

# 80i-2010s

## AC/DC Current Clamp

### *Instructions*

#### ***Introduction***

Use the Fluke 80i-2010s AC/DC Current Clamp (the Clamp or Product) with oscilloscopes and digital multimeters and power analyzers for accurate non-intrusive measurements of ac, dc, and complex waveform currents.

Using advanced Hall Effect technology, the Clamp can accurately measure currents up to 2000 A RMS. These features make it a powerful tool for use in inverters, switch mode power supplies, industrial controllers, automotive diagnostics, and other applications requiring current measurements and/or waveform analysis.

Table 1 shows the Clamp.

#### ***How to Contact Fluke***

To contact Fluke, call one of the following telephone numbers:

- Technical Support USA: 1-800-44-FLUKE (1-800-443-5853)
- Calibration/Repair USA: 1-888-99-FLUKE (1-888-993-5853)
- Canada: 1-800-36-FLUKE (1-800-363-5853)
- Europe: +31 402-675-200
- Japan: +81-3-6714-3114
- Singapore: +65-6799-5566
- China: +86-400-921-0835
- Brazil: +55-11-3530-8901
- Anywhere in the world: +1-425-446-5500

Or, visit Fluke's website at [www.fluke.com](http://www.fluke.com)

To view, print, or download the latest manual supplement, visit <http://us.fluke.com/usen/support/manuals>.

Go to [www.fluke.com](http://www.fluke.com) to register your product and find more information.

Table 1. 80i-2010s AC/DC Current Clamp

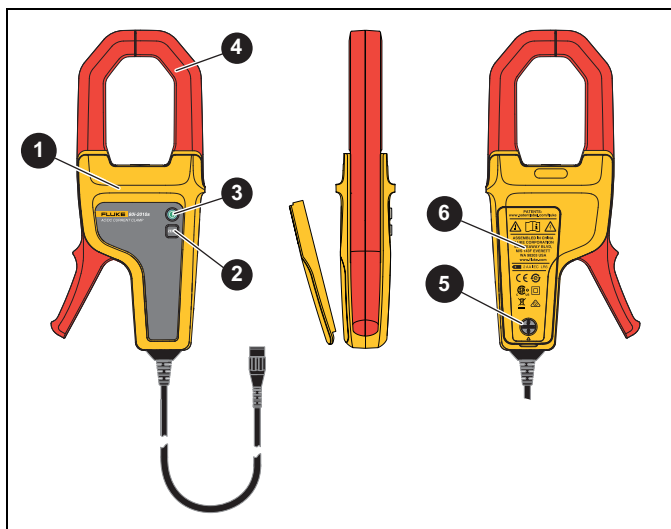

Item	Description	Item	Description
1	Tactile Barrier	4	Jaws
2	Zero Adjust	5	Battery Cover Fastener
3	ON/OFF	6	Battery Cover

## Safety

A **Warning** identifies conditions and procedures that are dangerous to the user.

### ⚠️⚠️ Warning







To prevent possible electrical shock, fire, or personal injury:

- Read all safety information before you use the Product.
- Use the Product only as specified, or the protection supplied by the Product can be compromised.
- Comply with local and national safety codes. Use personal protective equipment (approved rubber gloves, face protection, and flame-resistant clothes) to prevent shock and arc blast injury where hazardous live conductors are exposed.
- Do not use the Product around explosive gas, vapor, or in damp or wet environments.
- Examine the case before you use the Product. Look for cracks or missing plastic. Carefully look at the insulation around the terminals.





- Use Product-approved measurement category (CAT), voltage, and amperage rated accessories (probes, test leads, and adapters) for all measurements.
- Do not use test leads if they are damaged. Examine the test leads for damaged insulation and measure a known voltage.
- Before each use, examine the Product. Look for cracks or missing pieces of the clamp housing or output cable insulation. Also look for loose or weakened components. Carefully examine the insulation around the jaws.
- Hold the Product behind the tactile barrier. See ❶ of Table 1.
- Do not use the Product if it is damaged.
- Do not use the Product if it operates incorrectly.
- The battery door must be closed and locked before you operate the Product.
- Remove all probes, test leads, and accessories before the battery door is opened.
- Do not work alone.
- Do not exceed the Measurement Category (CAT) rating of the lowest rated individual component of a Product, probe, or accessory.
- Do not touch voltages >30 V ac rms, 42 V ac peak, or 60 V dc.
- Have an approved technician repair the Product.

Table 2 shows symbols that can be used on the Product or in this document.

**Table 2. Symbols**

Symbol	Definition
	WARNING - RISK OF DANGER.
	WARNING. HAZARDOUS VOLTAGE. Risk of electric shock.
	Consult user documentation.
	Double Insulated
	Application around and removal from uninsulated hazardous live conductors is permitted.
	Battery
	Certified by CSA Group to North American safety standards.

**Table 2. Symbols (Continued)**

Symbol	Definition
	Conforms to European Union directives.
	Conforms to relevant Australian Safety and EMC standards.
	Conforms to relevant South Korean EMC Standards.
<b>CAT III</b>	Measurement Category III is applicable to test and measuring circuits connected to the distribution part of the building's low-voltage MAINS installation.
<b>CAT IV</b>	Measurement Category IV is applicable to test and measuring circuits connected at the source of the building's low-voltage MAINS installation.
	This product complies with the WEEE Directive marking requirements. The affixed label indicates that you must not discard this electrical/electronic product in domestic household waste. Product Category: With reference to the equipment types in the WEEE Directive Annex I, this product is classed as category 9 "Monitoring and Control Instrumentation" product. Do not dispose of this product as unsorted municipal waste.

## **Operating Instructions**

### **Warning**

To prevent possible electrical shock, fire, or personal injury:

- **When using the Clamp, ensure that your fingers are behind the protective barrier as shown in Table 1.**
- **Do not use the Clamp if any part, including the lead and connector(s), appears to be damaged or if a malfunction of the instrument is suspected.**
- **Before using the clamp make sure there is no dust or any small debris on the closing faces of the jaw.**
- **Close the jaws gently and avoid closing them with high-impact. The force of the impact can affect the accuracy of the measurement.**

### **Turn on the Clamp**

Push  for 2 seconds to turn on/off the clamp.

- Green LED indicates the Clamp is ON and the battery is ok.
- Orange LED indicates the battery is lower than 2.2 V.
- Red LED indicates the battery is lower than 2 V. Replace the battery before doing a measurement.

## Zero Adjustment

The output zero offset voltage of the Clamp may change due to thermal shifts and other environmental conditions. To adjust the output voltage to zero:

1. Make sure that the Clamp is away from the current carrying conductor.
2. Push **Zero Adjust** and wait until the power LED (①) stops flashing.

### Note

*The Clamp cannot do the zero adjustment if the output voltage is  $\pm 25$  mV.*

## Current Measurement

To measure current:

1. Turn on the Clamp and check the LED status.
2. Connect the output lead/adaptor to an oscilloscope, multimeter, power analyzer, or other measuring equipment.
3. If necessary, adjust the Clamp output voltage to zero as described in the section [Zero Adjustment](#).
4. Clamp the jaw around the conductor and make sure there is good contact between the closing faces of the jaw.
5. Take measurements as required. Positive output indicates that the current flow is in the direction shown by the arrow on the clamp.

## Maintenance

Before each use, inspect the Clamp. Look for cracks or missing portions of the housing and output cable insulating cover and for loose or weakened components.

## Cleaning and Storage

Periodically wipe the case with a damp cloth and detergent. Do not use abrasives or solvents. Do not immerse the Clamp in liquids.

## Battery Replacement

### Warning

**To prevent possible electrical shock, fire, or personal injury:**

- **Replace the batteries when the low battery indicator shows to prevent incorrect measurements.**
- **Always remove the Clamp from any live electric circuit, and make sure leads are disconnected before removing the battery cover.**
- **Never operate the Clamp without the battery cover installed.**

When the clamp approaches the minimum operating voltage, the red LED indicates the battery is low.

To replace the battery (see Figure 1):

1. Disconnect the Clamp from any conductor.
2. Turn off the Clamp.
3. Disconnect the output leads from external equipment.

4. Locate the battery cover on the handle and unlock the fastener.
5. Remove the battery door and install the new batteries (IEC LR6).
6. Replace the battery cover, and lock the fastener.

*Note*

*Replace the battery with the specified type only. Replacing with the wrong battery type will invalidate the warranty.*

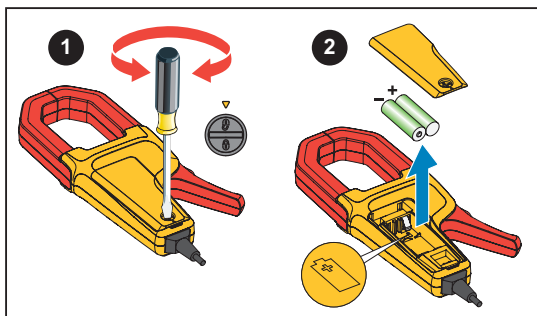

**Figure 1. Battery Installation**

### **General Specifications**

Dimensions.....	110 mm x 270 mm x 46 mm
Weight .....	710 g
Output Cable .....	1.5 m Shielded Coaxial cable with BNC male connector
Maximum Conductor Diameter.....	52.0 mm
Maximum Jaw Opening.....	81.5 mm
Output to Zero .....	Auto adjustment with zero button
Temperature	
Operating .....	-10 °C to 50 °C
Storage (battery removed) .....	-30 °C to +60 °C
Operating Humidity .....	≤90 % RH (at 10 °C to 30 °C) ≤75 % RH (at 30 °C to 40 °C) ≤45 % RH (at 40 °C to 50 °C)
Altitude	
Operating.....	2000 m
Storage.....	12 000 m
Demagnetize Clamp .....	Open and gently close the Clamp jaws several times
Use of the clamp on <b>non-insulated conductors</b> is limited to 1000 V ac rms or dc and frequencies below 1 kHz	
Safety .....	IEC 61010-1, Pollution Degree 2 IEC 61010-2-032: CAT III 1000 V / CAT IV 600 V
Ingress Protection .....	IEC 60529, IP40

## Electromagnetic Compatibility (EMC)

International..... IEC 61326-1: Portable  
Electromagnetic Environment  
IEC 61326-2-2, CISPR 11: Group 1,  
Class A

*Group 1: Equipment has intentionally generated and/or use  
conductively coupled radio-frequency energy which is necessary for  
the internal functioning of the equipment itself.*

*Class A: Equipment is suitable for use in all establishments other  
than domestic and those directly connected to a low voltage power  
supply network which supplies buildings used for domestic purposes.  
There may be potential difficulties in ensuring electromagnetic  
compatibility in other environments, due to conducted and radiated  
disturbances.*

*Emissions that exceed the levels required by CISPR 11 can occur  
when the equipment is connected to a test object.*

Korea (KCC) ..... Class A Equipment (Industrial Broadcasting &  
Communication Equipment)

*Class A: Equipment meets requirements for industrial  
electromagnetic wave equipment and the seller or user should take  
notice of it. This equipment is intended for use in business  
environments and not to be used in homes.*

## **Electrical Specifications**

All accuracies stated at 23 °C ±1 °C (73.4 °F ±1.8 °F)

Current Range ..... 2000 A ac rms, ±2000 A dc

Output Sensitivity ..... 1 mV/A

Accuracy..... ±0.8 % of reading ±0.2 % of range

Bandwidth to Meet

Accuracy Specification ..... DC to 400 Hz

Load impedance ..... >1 MΩ and <10 pF

Frequency Response

(small signal) ..... DC to 20 kHz (-3 dB)

Temperature Coefficient..... Add 0.1 x specified accuracy for each  
degree C above 28 °C or below 18 °C

Working Voltage ..... 1000 V ac rms or dc

Power Supply

Type ..... 2x AA alkaline battery, IEC LR6

Battery Life ..... 150 hours

Low battery indicator ..... yes

## LIMITED WARRANTY AND LIMITATION OF LIABILITY

This Fluke product will be free from defects in material and workmanship for one year from the date of purchase. This warranty does not cover fuses, disposable batteries, or damage from accident, neglect, misuse, alteration, contamination, or abnormal conditions of operation or handling. Resellers are not authorized to extend any other warranty on Fluke's behalf. To obtain service during the warranty period, contact your nearest Fluke authorized service center to obtain return authorization information, then send the product to that Service Center with a description of the problem.

**THIS WARRANTY IS YOUR ONLY REMEDY. NO OTHER WARRANTIES, SUCH AS FITNESS FOR A PARTICULAR PURPOSE, ARE EXPRESSED OR IMPLIED. FLUKE IS NOT LIABLE FOR ANY SPECIAL, INDIRECT, INCIDENTAL OR CONSEQUENTIAL DAMAGES OR LOSSES, ARISING FROM**

**ANY CAUSE OR THEORY.** Since some states or countries do not allow the exclusion or limitation of an implied warranty or of incidental or consequential damages, this limitation of liability may not apply to you.

Fluke Corporation  
P.O. Box 9090  
Everett, WA 98206-9090  
U.S.A.

Fluke Europe B.V.  
P.O. Box 1186  
5602 BD Eindhoven  
The Netherlands

Beijing Fluke  
Rm101, 1/F., Tong Heng Tower  
No. 4 Hua Yuan Road Hai Dian  
District, Beijing 100088, P.R.C.