

# **HIOKI**

---

---

Quick Start Manual

**3169-20**

**3169-21**

## **CLAMP ON POWER HiTESTER**

**HIOKI E. E. CORPORATION**

July 2014 Revised edition 7 3169A983-07 14-07H

---



\*600029257\*



---

# Contents

---

<b>Introduction</b>	<b>1</b>
<b>Key Names and Functions</b>	<b>2</b>
Screen Configuration .....	3
Common Display .....	4
On-Screen Indicators .....	5
<b>Power Measurement</b>	<b>6</b>
Measurement Preparations .....	9
Basic Settings .....	15
Connect the Voltage Cords and Clamp Sensors to the line to be Measured .....	18
Confirm the Range .....	20
Checking the Wiring .....	22
Measurement Settings .....	24
Start Measurement .....	27
View Measured Value .....	28
Stop Measurement .....	29
Headers of Output Data .....	31

---



# Introduction

The 3169-20 and the 3169-21 Clamp On Power HiTester is supplied with a instruction manual in addition to this manual. Please be sure to read both manuals.

This manual provides a simplified description of the instrument (key names and functions as well as screens) and measurement process, from the preparation stage to the completion of measurement, using an example application.

For current input with this instrument, a clamp-on sensor (optional) is required. For details, refer to the instruction manual for the clamp-on sensor you are using.

Be sure to review the instruction manual carefully before using the instrument to ensure safe operation.







## Model Numbers

In this manual, "3169" is used as the instrument model.

Model No.	D/A output function
3169-20	Not available
3169-21	Available

## Notation

In this manual, the risk seriousness and the hazard levels are classified as follows.

 <b>DANGER</b>	Indicates an imminently hazardous situation that will result in death or serious injury to the operator.
 <b>WARNING</b>	Indicates a potentially hazardous situation that may result in death or serious injury to the operator.
 <b>CAUTION</b>	Indicates a potentially hazardous situation that may result in minor or moderate injury to the operator or damage to the instrument or malfunction.
	Indicates prohibited actions.
<b>See</b> 	Indicates the reference.
	Indicates a useful measurement tip or fact.
*	Additional information is presented below.

# Key Names and Functions

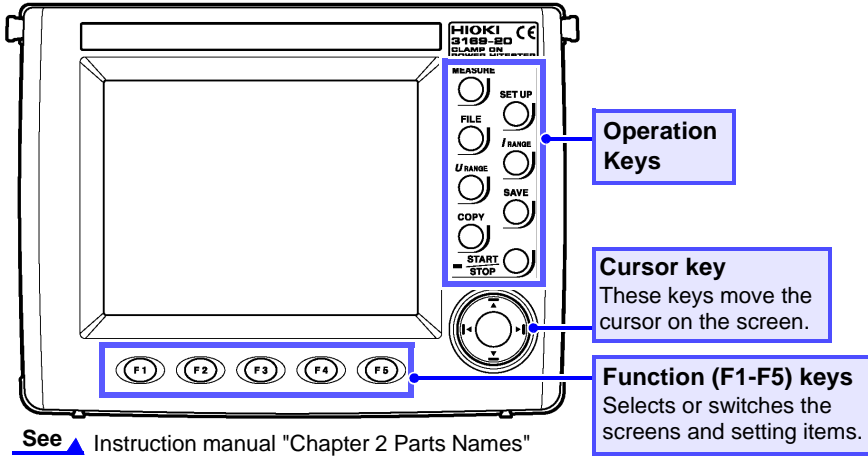

## Operation Keys

<b>MEASURE key</b>	Switches to a screen that displays measurements.
<b>SET UP key</b>	Switches to a screen that displays settings or the next screen.
<b>FILE key</b>	Used to work on files.
<b>I RANGE key</b>	Sets the current measurement range for the circuit to be measured on-screen.
<b>U RANGE key</b>	Sets the voltage measurement range.
<b>SAVE key</b>	Enables the manual saving of measurement data on the PC card or in internal memory. Manual saving is not possible during time-series measurement.
<b>COPY key</b>	Outputs screen image data to the PC card, internal memory, or a printer.
<b>START/STOP key</b>	Starts or stops time-series measurements including integration measurement.
<b>START/STOP LED</b>	Flashes in green while the instrument is standing by for time-series measurement, and lights in green while the instrument is performing time-series measurement.

# Screen Configuration

The screens are divided into three basic types: measurement screens, setting screens, and file screens. Each screen is selected using three operation keys: **MEASURE**, **SET UP**, and **FILE**.

MEASURE Measurement screen

MAIN	INST.	CIRCUIT1	2012-07-24 18:22:21
U1	201.09 V	I1	9.092 A
U2	201.09 V	I2	9.096 A
U3	200.97 V	I3	9.094 A
Uave	201.05 V	Iave	9.094 A
		I4	0.1378 A
P1	1.5864kW	Q	2.7221kvar
P2	1.5888kW	S	5.4650kVA
P3	1.5866kW	PF	0.8682
P	4.7618kW	f	49.998 Hz
WP+	0.00000kWh		0:00:00
SCREEN	AVERAGE	HOLD	

**MAIN**  
**POWER**  
**INTEGRATE**  
**DEMAND**  
**ZOOM**  
**HARMONIC LIST**  
**HARMONIC GRAPH**  
**WAVEFORM**  
**WIRING CHECK**  
**WIRING DIAGRAM**

FILE

File screen

FILE MAIN	2012-07-24 18:22:22
<b>INTERNAL SETTINGS</b>	
INTERNAL MEMORY	
PC CARD	
FIRMWARE UPDATE	
SELECT	

**INTERNAL SETTINGS**  
**INTERNAL MEMORY**  
**PC CARD**  
**FIRMWARE UPDATE**

SET UP

Setting screen

SET UP	1/5 MEASUREMENT	2012-07-24 18:22:22
WIRING	1P2W x4	
SAMPLING	PLL 50Hz	
VAR METHOD	OFF	
AVERAGE TIMES	1	
VOLTAGE	U1	
RANGE	300 V	
VT(PT)	0001.00	
CURRENT	CH1	CH2
RANGE	100 A	500 A
	5 A	10 A
CT	0001.00	0001.00
	0001.00	0001.00
SENSOR	9661	9660
	9660	9660
change		NEXT SCR

**MEASUREMENT**  
**DATA OUTPUT**  
**SAVE, PRINT ITEMS**  
**SYSTEM**  
**D/A OUTPUT (3169-21 only)**

## Common Display

This section of the screen shows information common to all measurement screens (except the zoom screen and the wiring diagram screen).

**Common Display**











MAIN	INST.	CIRCUIT1		2012/05/19 17:12:21	Time
U1	201.09 V	I1	9.092 A	U 300V × 1.00	Range
U2	201.09 V	I2	9.096 A	I 10A × 1.00	
U3	200.97 V	I3	9.094 A	I4 1.50 × 1.00	
Uave	201.05 V	Iave	9.094 A		
		I4	0.1378 A	WIRING 3P4W4I	Wiring
P1	1.5864kW	Q	2.7221kvar	CIRCUIT ×1	No. of circuits
P2	1.5888kW	S	5.4850kVA	PLL U1 50Hz	Synchronization method
P3	1.5866kW	PF	0.8682	INTVL. 1min	Interval
P	4.7618kW	f	49.998 Hz		
WP+	0.00000kWh		0:00:00		
SCREEN	AVERAGE	HOLD			

<b>Time</b>	Displays the current time.
<b>Range</b>	Displays the voltage range and current range of the on-screen circuit. The VT(PT) ratio and CT ratio are shown under these ranges. The current range and CT ratio of I4 are shown only when 3P4W4I is set as the wiring method.
<b>Wiring</b>	Displays the wiring method set on the setting screen.
<b>No. of circuits</b>	Displays the number of circuits to be measured as set on the setting screen.
<b>Synchronization method</b>	Displays the synchronization method and frequency of the line to be measured as set on the setting screen.
<b>Interval</b>	Displays the interval set on the setting screen.



## On-Screen Indicators

MAIN		INST.		CIRCUIT1		VAR	2012/06/25
							14:05:53
U1	over V	I1	over A	U	150V		
U2	over V	I2	over A	I	5A		
U3*	over V	I3*	over A		x 1.00		
Uave	over V	Iave	over A				
P	over kW	Q	over kvar	WIRING			
		S	over kVA	3P3W2M			
		PF	over	CIRCUIT	x2		
		f	50.000 Hz	PLL	U1		
WP+	0.000 Wh		0:00:00	INTVL.	1min		
SCREEN			CIRCUIT AVERAGE			HOLD	

	Goes on when the reactive-power-meter method is ON. <b>See</b> ▲ Instruction manual "5.2.3 Setting the Reactive-Power Meter Method"
	Goes on when the displayed measurement is held.
	Goes on when the medium for saving data is set to PC card. Flashes when the PC card is accessed.
	Goes on when the medium for saving data is set to internal memory. Flashes when the internal memory is accessed.
	Goes on when the PC card or internal memory is full.
	Goes on when the device to be connected to the RS-232C is set to PC.
	Goes on when the device to be connected to the RS-232C is set to printer.
	Goes on when the PLL is unlocked; the synchronization method is automatically switched over to the fixed clock. <b>See</b> ▲ Instruction manual "5.2.2 Setting the Synchronization Method"
	Goes on when the keys are locked.
	Goes on when the voltage or current dynamic range is exceeded.
over	Displayed when the range is exceeded.

### Reference

U3\* and I3\* indicate that the data is obtained by calculating the 2-voltage, 2-current measurement results when 3P3W2M (three-phase, 3-wire, 2-power-meter method) is selected.

**See** ▲ Instruction manual "Appendix"

# Power Measurement

This chapter explains setting and measurement procedures using the following example.

Be sure to read the "Operating Precautions" section of the instruction manual as well as other precautionary information that can be found its chapters before using the instrument.

## Example:

### Measure the power of a Three-phase 3-wire 200 V line for 7 days.

- Data is automatically output to the PC card at 5-minute intervals.
- Average value (voltage, current, and power) and integrated power are stored on the PC card.
- The reactive power-meter method\* is not used.

## Procedures

See p.8 for more information about what you will need to perform measurement.

1. Connect the power cord. (p.10)



2. Connect the voltage cord to the 3169. (p.11)



3. Connect the clamp sensor to the 3169. (p.12)



4. Insert the PC card. (p.13)



5. Turn the Power switch ON. (p.14)



6. Basic settings (p.15)



7. Connect the voltage cords and clamp sensors to the line to be measured. (p.18)



8. Confirm the range. (p.20)



9. Checking the wiring. (p.22)



10. Measurement settings (p.24)



11. Start measurement. (p.27)

\* The reactive-power-meter method is used to measure reactive power directly from the voltage and current, like a reactive power meter installed for large power consumers.

12. View measured values (p.28)

13. Stop measurement. (p.29)

### System diagram

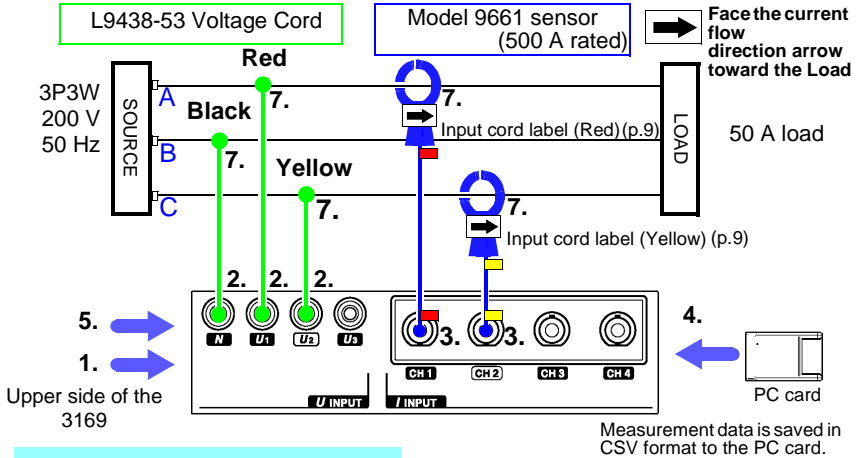

### 6. Basic Settings (Measurement Setting Screen)

Wiring method : 3P3W2M  
 Number of circuits to be measured : x 1 (1 circuit)  
 Sampling : PLL  
 Frequency : 50 Hz  
 VAR Method : OFF  
 Average times : 1  
 Voltage range : 300 V  
 Current range : 50 A  
 Sensor : Model 9661

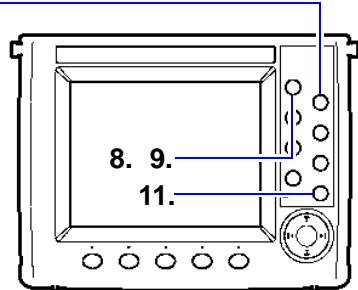

### 10. Measurement Method (Data Output Setting Screen)

Meas. Start : Time (2012/06/20 08:00)  
 Meas. Stop : Time (2012/06/27 08:00)  
 Interval time : 5 minutes  
 Medium for saving data : PC card  
 Data file name : user specified

### Measurement Method (Save/Print Items Setting Screen)

Normal measurement : ON  
 Average : ON  
 Integrated power&demand : ON

## Instrument and Accessories Required for Measurement

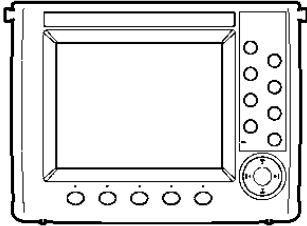

Model 3169 x 1

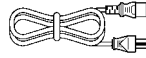

Power cord x 1



PC card (optional) x 1

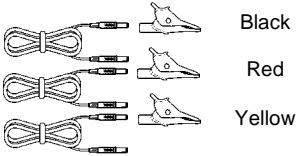

Model L9438-53 Voltage Cord x 3

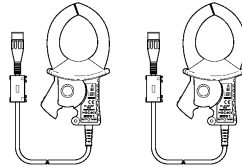

Model 9661 Clamp on Sensor x 2  
(optional)



Spiral tubes x 5  
(for banding the cords)

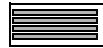

Input cord label x 1

# Measurement Preparations

1. Wind the spiral tubes around the cords as necessary.

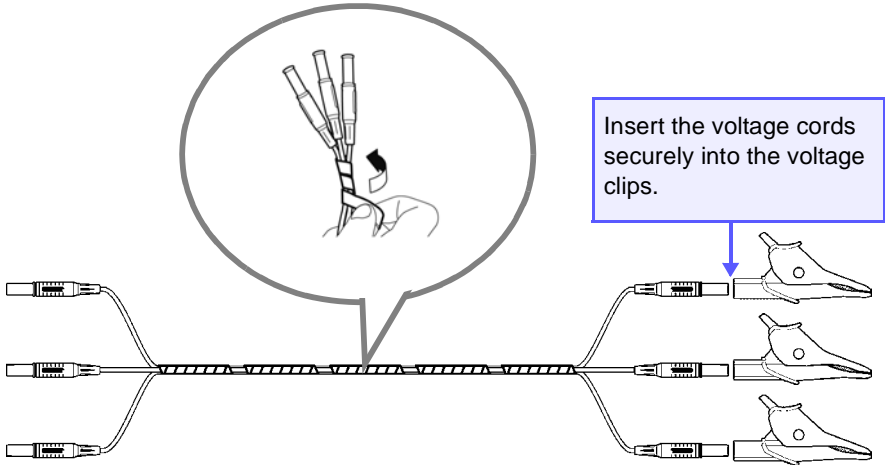

2. Attach the input cord labels as necessary.

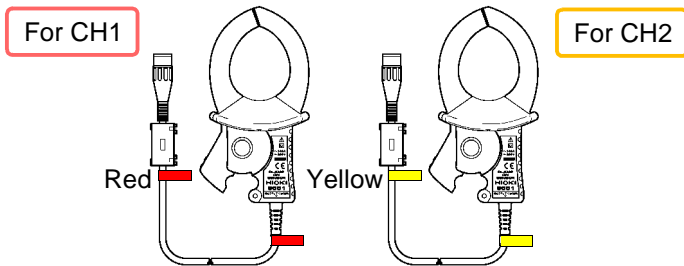

### 3. Connect the power cord.



To avoid electrical accidents and to maintain the safety specifications of this instrument, connect the power cord provided only to a 3-contact (two-conductor + ground) outlet.

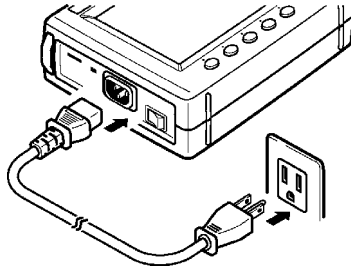

#### 4. Connect the Voltage cord to the voltage input terminals of the 3169.

### ! DANGER

- Connect the voltage cords to the instrument first, and then to the active lines to be measured. Observe the following to avoid electric shock and short circuits.
- Voltage cord should only be connected to the secondary side of a breaker, so the breaker can prevent an accident if a short circuit occurs. Connections should never be made to the primary side of a breaker, because unrestricted current flow could cause a serious accident if a short circuit occurs.
- Do not allow the voltage cord clips to touch two wires at the same time. Never touch the edge of the metal clips.
- Voltage input terminals  $U_1$ ,  $U_2$ , and  $U_3$  are common to the N terminal and are not insulated. To avoid the risk of electric shock, do not touch the terminals.
- To prevent an electric shock accident, confirm that the white or red portion (insulation layer) inside the cable of voltage cord is not exposed. If a color inside the cable is exposed, do not use the cable.

### ! CAUTION

For safety reasons, when taking measurements, only use the L9438-53 Voltage Cord provided with the instrument.

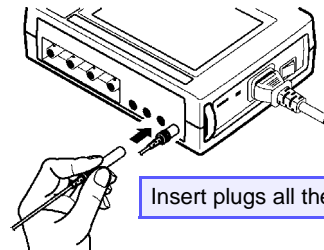
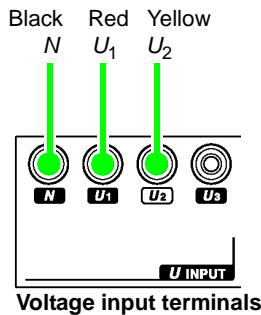

Insert plugs all the way in.

## 5. Connect the clamp sensor (Model 9661) to the current input terminals of the 3169.



### CAUTION

When disconnecting the BNC connector, be sure to release the lock before pulling the connector. Forcibly pulling the connector without releasing the lock, or pulling on the cable, can damage the connector.

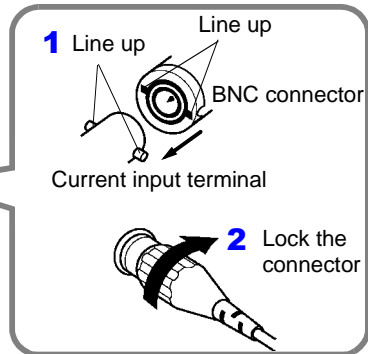
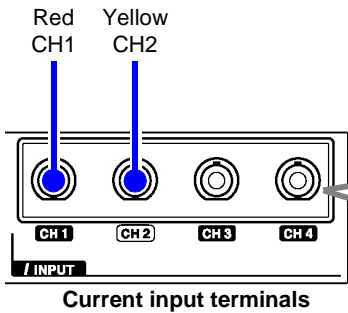

Verify that each channel color matches the color of each input code label.



## 6. Insert the PC card into the 3169.

### ! WARNING

Use only PC Cards sold by Hioki. Compatibility and performance are not guaranteed for PC cards made by other manufacturers. You may be unable to read from or save data to such cards.

### ! CAUTION

- Inserting a PC card upside down, backwards or in the wrong direction may damage the instrument.
- Never eject a PC card while it is being accessed by the instrument. Data on the PC card may be lost.
- Some PC cards are susceptible to static electricity. Exercise care when using such products because static electricity could damage the PC card or cause malfunction of the instrument.
- With some PC cards, the instrument may not start up if power is turned on while the PC card is inserted. In such a case, turn power on first, and then insert the PC card. It is recommended to try out operation with a PC card before starting to use it for actual measurements.

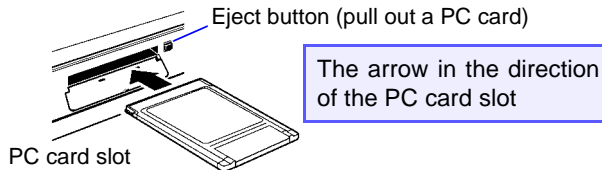

## 7. Turn the POWER switch ON.

### WARNING

Before turning the instrument on, make sure the supply voltage matches that indicated on its power connector. Connection to an improper supply voltage may damage the product and present an electrical hazard.

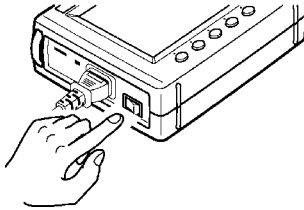

**See** ▲ How to set the clock  
Instruction manual  
"5.5.7 Setting the Clock"

## 8. Adjusts the contrast of the screen as necessary.

Contrast  
control knob

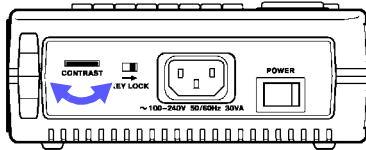



# Basic Settings

**See** ▲ To initialize settings (p.17)

1. Press the  key to display the setting screen.

If the following screen is not displayed, press the **SET UP** key several times.

2. Set all items as shown on the screen below.

Move the cursor to the setting you wish to configure with the  key and set it with the  to  keys.

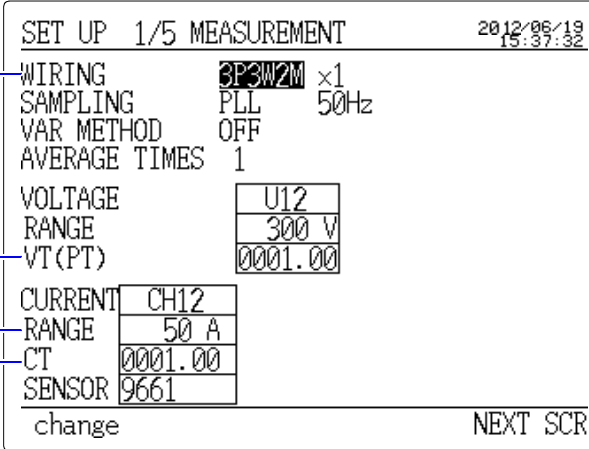

SET UP 1/5 MEASUREMENT		2012/06/19 15:37:32
1	WIRING	3P3W2M x1
	SAMPLING	PLL 50Hz
	VAR METHOD	OFF
	AVERAGE TIMES	1
	VOLTAGE	U12
	RANGE	300 V
2	VT(PT)	0001.00
	CURRENT	CH12
3	RANGE	50 A
4	CT	0001.00
	SENSOR	9661
	change	NEXT SCR

**See** ▲

Instruction manual  
"5.2 Setting on the  
Measurement Setting Screen (MEASUREMENT)"



## 1 Two methods for performing 3-phase/3-wire power measurement

- 3-phase/3-wire/2-meter (3P3W2M) method:  
Power is calculated from two sets of voltage and current values (use for normal measurement).
- 3-phase/3-wire/3-meter (3P3W3M) method:  
Power is calculated from three sets of voltage and current values (use when you wish to verify each phase's power balance).



### What is VT ratio?

VT is used in high-voltage measurement to convert (step-down) the voltage measured to a smaller level and supply the conversion result to an instrument. VT ratio (voltage transformation ratio): A ratio used to convert the secondary voltage of VT to the primary voltage.

#### Example

When the primary voltage is 6600 V and the secondary voltage is 110 V, the VT ratio is 60 (6600 V/110 V). In this case, as the rated measurement voltage is 110 V, set the voltage range to 150 V.



### Clamp sensor and current range:

Selectable current ranges vary according to the clamp sensor used. Choose a clamp sensor head as appropriate for the measurement target.

Clamp sensors	Range
Model 9660, 9695-03	5 A, 10 A, 50 A, 100 A
Model 9661	5 A, 10 A, 50 A, 100 A, 500 A
Model 9667-5kA (5000 A range)	5 kA
Model 9667-500A (500 A range)	500 A
Model 9669	100 A, 200 A, 1 kA
Model 9694	0.5 A, 1 A, 5 A
Model 9695-02	0.5 A, 1 A, 5 A, 10 A, 50 A

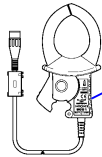

Model number and the maximum rated current

#### Reference

When using the CT9667 sensor, choose “9667” for the sensor on the Measurement Setting screen.



### What is CT ratio?

CT is used to measure large current to reduce the current measured to a smaller level and supply the conversion result to an instrument. CT ratio (current transformation ratio): A ratio used to convert the secondary current of CT to the primary current.

When the primary current is 100 A and the secondary current is 5 A, the CT ratio is 20 (100 A/5 A). In this case, as the rated measurement current is 5 A, set the current range to 5 A.



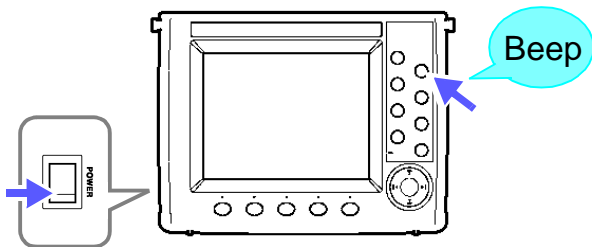

## To initialize settings

1. Turn the power OFF.
2. Turn the power ON again while holding the **SET UP** key. Press and hold the key until you hear a beep.
3. A system reset will return all settings of the 3169 (except for the clock) to the defaults. The time setting will not be reset.





## Connect the Voltage Cords and Clamp Sensors to the line to be Measured

1. Press the  key to display the measurement screen.
2. Press the  (SCREEN) key to display the selection window.

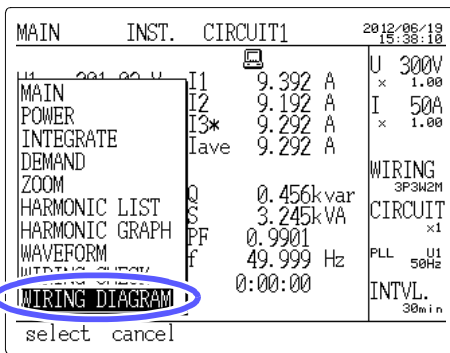
(The following screenshot illustrates the Main Measurement screen being switched to the Wiring Diagram screen.)



3. Press the  key to move the cursor to "WIRING DIAGRAM".
4. Press the  (select) key to display the wiring diagram screen.

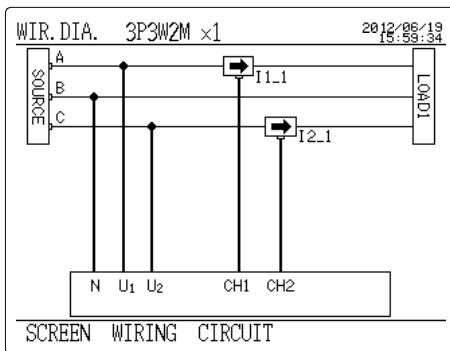

## 5. Connect the Voltage cords and the clamp sensors to the line to be measured, while referring to the wiring diagram.

We recommend that the color of a voltage cord be matched to that of the attached input-cord label used for the same channel.

According to the sensor, the shape and position of the arrow mark varies.



**Face the current flow direction arrow toward the Load**

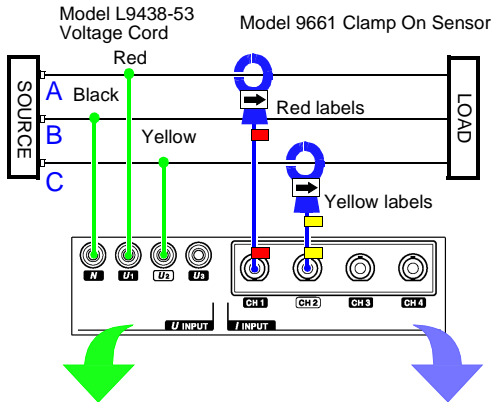

### Example

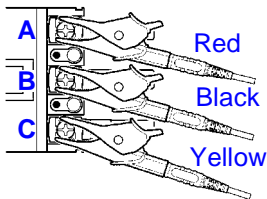

Clip securely to **metal parts** such as connection screws or bus bars at the secondary side (the load side) of a breaker.

If you have difficulty clipping screws, you may find it convenient to use an optional magnet adapter (Model 9804-01, Model 9804-02).

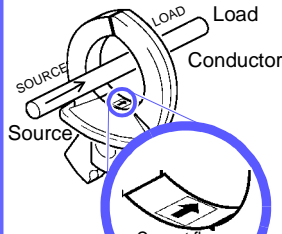

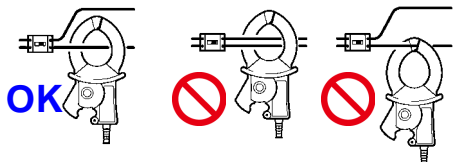

The arrows on the clamp indicating the direction of current flow should point toward the load side.



Clamp around only one conductor. Measurement is not possible if the clamp is placed around two lines in a single-phase circuit, or three lines in a three-phase circuit.

## Confirm the Range

1. Press the  key to display the measurement screen.
2. Press the  (SCREEN) key to display the selection window.

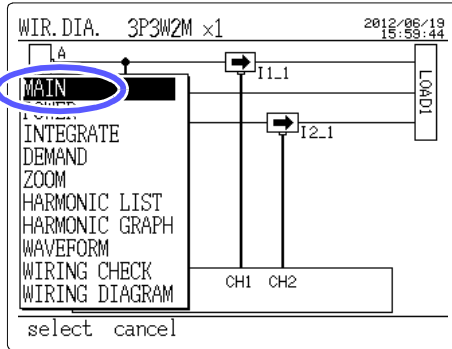

3. Press the  key to move the cursor to "MAIN".

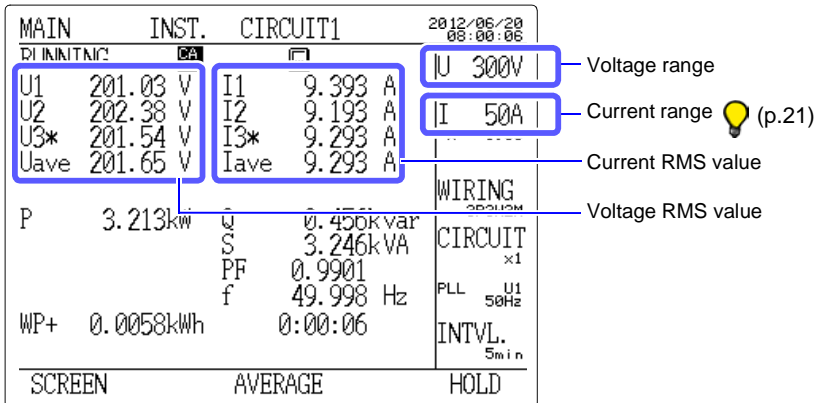

4. Press the  key or  key to select an appropriate range.





## Choosing the current range

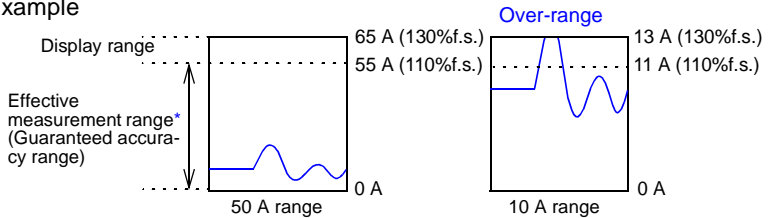

Set the current range based on your expectation of the maximum load current that will flow during the measurement period. (Select an appropriate range based on factors such as the operating state, rated load, and breaker rating.) When the range is too low, an over-range event will occur during measurement, preventing accurate measurement. When the range is too high, the magnitude of the error component will increase, preventing accurate measurement.

### Example





\* Effective measurement range: 5% to 110% of range  
 Display range: 0.4% to 130% of range

## Checking the Wiring

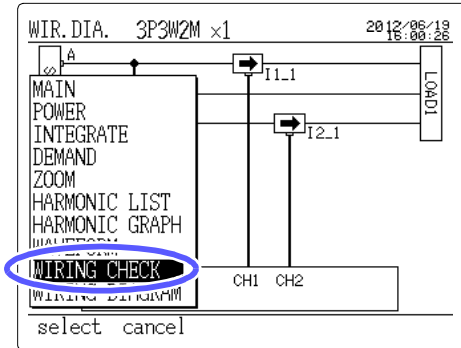
1. Press the  key to display the measurement screen.
2. Press the  (SCREEN) key to display the selection window.



3. Press the  key to move the cursor to "WIRING CHECK".
4. Press the  (select) key to display the wiring check result.

The connection status is shown by the voltage, current vectors, and the connection check result.

If the wiring check result is "NG," check the wiring.

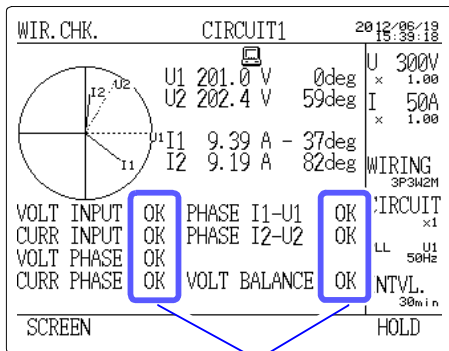

 The wiring check result is **NG**. (p.23)

The displayed voltage and current levels and phase angle are for the fundamental component. These values differ from RMS values.



### The wiring check result is NG.

Check the following:

Issue	What to check	Reference
<b>The voltage input is NG.</b>	• Are you sure that the voltage clip is connected to the metallic part of the object to be measured?	(p.19)
	• Is the voltage cord properly inserted into the voltage input terminal of the 3169?	(p.11)
	• Is the voltage cord properly inserted into the voltage clip?	(p.10)
<b>The current input is NG.</b>	• Is the clamp-on sensor securely inserted into the current input terminals?	(p.12)
	• Is the set current range too large for the input? If the current range is too large, change the current range setting to a lower range to have the measurement values more than 5% of the set range.	(p.21)
<b>The voltage phase is NG.</b>	• Are the voltage cords properly connected? (To both the object under measurement and the instrument)	(p.11) (p.19)
<b>The current phase is NG.</b>	• Does the current flow direction arrow of the clamp-on sensor point to the load side?	(p.19)
	• Are the clamp-on sensors properly connected? (To both the object under measurement and the instrument)	(p.12) (p.19)
<b>The phase difference (I-U) is NG.</b>	• Are the voltage cords and clamp-on sensors properly connected? (To both the object under measurement and the instrument)	(p.11) (p.19)
	• Does the current flow direction arrow of the clamp-on sensor point to the load side?	(p.19)
	• Is the power factor of the line to be measured 0.5 or less? If the power factor is less than 0.5, the phase difference (I-U) will show NG even if the wires are properly connected. When the connection is visually confirmed as being appropriate, the measurement values will be correct even if a NG judgment is given.	-
<b>The voltage balance is NG.</b>	• Does the connection method of the line to be measured differ from that set?	(p.15)
	• Are you sure that the voltage clip is connected to the metallic part of the object to be measured?	(p.19)
	• Is the voltage cord properly inserted into the voltage input terminal of the 3169?	(p.11)

**Reference** The wiring check function may indicate improper connection ("NG") even when the actual wiring is correct, or vice versa. Check the vectors and measurement data as well.

## Measurement Settings

1. Press the  key as many times as necessary to display the Data Output Setting screen.
2. Set as shown on the screen below.

SET UP 2/5 DATA OUTPUT		2012/06/19 16:02:27
MEAS. START	TIME	2012/06/20 08:00
MEAS. STOP	TIME	2012/06/27 08:00
INTERVAL TIME		5 min
SAVE IN...		PC CARD
DATA FILE NAME		<input type="text"/>
RS CONNECTION		PC
DISPLAY COPY		PC CARD
-	+	AUTO
		NEXT SCR

 1  
(p.25)

 2  
(p.25)

 **AUTO**

If **F3 (AUTO)** key is pressed when the cursor is at the measurement start time, the start time will be set to a date and time close to the current time.

The time that is set will vary with the interval time setting. (For example, if the current time is 7:58 and the interval time is 5 min., this parameter will be set to 8:00.)

If a filename is not specified or a file with the same name exists on the PC card, the file will automatically be named "69MEASXX" (XX: 00 to 99).

**See**  Instruction manual  
"5.3 Setting on the Data Output Setting Screen (DATA OUTPUT)"



## 1 Three methods for starting and stopping measurement

### Measurement start

Selection	Description
MANUAL	Measurement starts when the <b>START/STOP</b> key is pressed.
<b>TIME</b>	<b>Measurement starts at the time set by users.</b>
JUST	Measurement will begin as soon as the internal clock reaches a time that is evenly divisible by the set interval.

### Measurement stop

Selection	Description
MANUAL	Measurement stops when the <b>START/STOP</b> key is pressed.
<b>TIME</b>	<b>Measurement stops at the time set by users.</b>
TIMER	Measurement stops when the duration set by the users has elapsed. 1 second to 8784 hours.



## 2 Storable Data According to Interval Setting

Interval setting	Extension (format)	Normal measurement data	Integrated power/demand measurement data	Harmonic measurement data
1/2/5/10/15/30/60 m	CSV (CSV)	Yes	Yes	Yes
1/2/5/10/15/30 s	CSV (CSV)	Yes	Yes	No
All wave/100/200/500 ms	BIN (Binary)	Yes (Instantaneous values only)	No	No

Yes: Can be stored No: Cannot be stored

3. Press the  key to display the save/print items setting screen.
4. Set as shown on the screen below.

SET UP 3/5 SAVE, PRINT ITEMS 2012/06/19 15:48:03

NO. OF ITEMS 39

NORM. MEAS.	<input checked="" type="checkbox"/>	INST.	<input type="checkbox"/>
		AVE.	<input checked="" type="checkbox"/>
HARMONIC	<input type="checkbox"/>	MAX.	<input type="checkbox"/>
		MIN.	<input type="checkbox"/>

INTEG. & DEM.

---

SAVE TIME AVAIL. 238 00:05:57

OFF ON NEXT SCR

If loading data into a commercial spreadsheet application, verify that this number is 256 or less.

#### See ▲



Instruction manual  
"5.4 Setting on the Save/  
Print Items Setting Screen  
(SAVE, PRINT ITEMS)  
"7.4 "Saving Measure-  
ment Data"

Indicates the amount of save time available on the currently inserted PC card. Verify that the time shown is not less than the measurement time.

#### Reference

- If the storable time is shorter than the measurement time, delete unnecessary files from the PC card or set interval time longer.
- For details on settings for harmonics measurement-data output, see 5.4.4 "Setting Harmonic Measurement-data Output Items" of the instruction manual.

# Start Measurement

- MEASURE
1. Press the  key to display the measurement screen.  
(As long as a Measurement screen is being displayed, you can start measurement, even if you're not viewing the Main Measurement screen.)
  2. Press the  key.

The 3169 is in standby mode (LED blinking).

MAT1	INST.	CIRCUIT1	2012/06/20 07:59:43
<b>WAITING</b>			
U1	201.04 V	I1	9.392 A
			U 300V x 1.00

When the measurement start time is reached, measurement will start automatically (the LED will light up).

MAT1	INST.	CIRCUIT1	2012/06/20 08:00:06
<b>RUNNING</b>			
U1	201.03 V	I1	9.393 A
U2	202.38 V	I2	9.193 A
U3*	201.54 V	I3*	9.293 A
Uave	201.65 V	Iave	9.293 A
P	3.213kW	Q	0.456kvar
S			3.246kVA
		PF	0.9901
		f	49.998 Hz
WP+	0.0058kWh		0:00:06
SCREEN	AVERAGE	HOLD	

LED flashing → Lit up

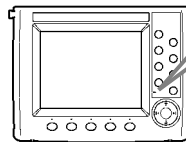
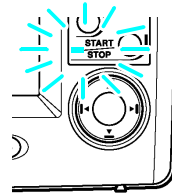

## View Measured Value

**Voltage RMS value of CH1**

Average voltage RMS value across channels

Active power

Active Energy (Consumption)

**Current RMS value of CH1**

Average current RMS value across channels

Reactive power

Apparent power

Power factor

Frequency

**F3**  
Pressing this key cycles the display through instantaneous, average, maximum, and minimum values.

MAIN	INST.	CIRCUIT1	2012/06/20
RUNNING	CA		
U1	201.03 V	I1	9.393 A
U2	202.38 V	I2	9.193 A
U3*	201.54 V	I3*	9.293 A
Uave	201.65 V	Iave	9.293 A
P	3.213kW	Q	0.456kvar
WP+	0.0058kWh	S	3.246kVA
		PF	0.9901
		f	49.998 Hz
			0:00:06
SCREEN	AVERAGE	HOLD	



### Switch Over to Another Screen

Press the **F1** (SCREEN) key to display the selection window, and select a screen to be viewed.

Example: To display the Integrate screen

MAIN	INST.	CIRCUIT1	2012/06/20
RUNNING			08:00:22
U1	201.03 V	I1	9.392 A
U2	202.38 V	I2	9.192 A
U3*	201.54 V	I3*	9.292 A
Uave	201.65 V	Iave	9.292 A
P	3.213kW	Q	0.456kvar
WP+	0.0058kWh	S	3.245kVA
		PF	0.9901
		f	50.002 Hz
			0:00:22
INTEGRATE			
ZOOM			
HARMONIC LIST			
HARMONIC GRAPH			
WAVEFORM			
WIRING CHECK			
WIRING DIAGRAM			
select	cancel		







## Stop Measurement

The 3169 will automatically stop measurement at the stop time. The measurement data has been saved on the PC card.



### Interrupt Measurement

Press the  key. The message "Do you want to stop the time-series measurement?" is displayed for you to confirm. Press the  (yes) key.

If the message "This key cannot be selected." is shown, press the  key to display the Measurement screen and then press the  key again.

All measurement data before the interruptions saved on the PC card if the measurement is interrupted.

## Shutdown Procedure

- 1. Disconnect the voltage cords and clamp-on sensor from the measured line.**
- 2. Turn off the power to the 3169.**
- 3. Disconnect the power cord from the AC outlet.**
- 4. Remove the PC card from the 3169.**

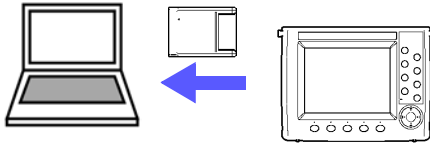

- 5. Copy the data on the PC card to the PC.**
- 6. Analyze the saved data on PC.**

You can analyze data on a PC with the optional SF1001 Power Logger Viewer. Additionally, data is saved to a CSV format file (p.25) when the interval setting is 1 sec. or greater, allowing that data to be loaded into a commercial spreadsheet application such as Excel\*.

- Using the SF1001 Power Logger Viewer (option)  
This software allows you to easily generate graphs on a PC using data recorded with the instrument. In addition to time-series graphs, ledger-style data, and daily, weekly, and monthly displays, it can also generate lists, graphs, and waveforms for harmonic measurement data.

\* Microsoft and Excel are either registered trademarks or trademarks of Microsoft Corporation in the United States and other countries.

# Headers of Output Data

## Instantaneous-Value Data (Normal Measurement), Integrated Power and Demand Value

Classification	Data Header	Contents	Unit
Date and Time	DATE	Data-output date, yyyy/m/d	
	TIME	Data-output time, h:mm:ss	
	ETIME	Elapsed time, hhhh:mm:ss	
Information	STATUS	10-bit data showing various pieces of status information	
Voltage	U1_INST[V]	Voltage RMS value, CH1	V
	U2_INST[V]	Voltage RMS value, CH2	V
	U3_INST[V]	Voltage RMS value, CH3	V
	Uave_INST[V]	Voltage RMS value, Average value of channels	V
Current	I1_INST[A]_1 to I1_INST[A]_4	Current RMS value, CH1, Circuit 1-4	A
	I2_INST[A]_1 to I2_INST[A]_2	Current RMS value, CH2, Circuit 1-2	A
	I3_INST[A]_1 to I3_INST[A]_2	Current RMS value, CH3, Circuit 1-2	A
	Iave_INST[A]_1 to Iave_INST[A]_2	Current RMS value, Average value of channels, Circuit 1-2	A
	I4_INST[A]_1	Current RMS value, CH4	A
Power	P_INST[W]_1 to P_INST[W]_4	Active power, Circuit 1-4	W
	Q_INST[var]_1 to Q_INST[var]_4	Reactive power, Circuit 1-4	var
	S_INST[VA]_1 to S_INST[VA]_4	Apparent power, Circuit 1-4	VA
Power Factor	PF_INST_1 to PF_INST_4	Power factor, Circuit 1-4	
Frequency	F_INST[Hz]	Frequency	Hz
Value of each channel	P1_INST[W]_1 to P1_INST[W]_2	Active power, CH1, Circuit 1-2	W
	P2_INST[W]_1 to P2_INST[W]_2	Active power, CH2, Circuit 1-2	W
	P3_INST[W]_1	Active power, CH3	W
	Q1_INST[var]_1 to Q1_INST[var]_2	Reactive power, CH1, Circuit 1-2	var
	Q2_INST[var]_1 to Q2_INST[var]_2	Reactive power, CH2, Circuit 1-2	var
	Q3_INST[var]_1	Reactive power, CH3	var
	S1_INST[VA]_1 to S1_INST[VA]_2	Apparent power, CH1, Circuit 1-2	VA
	S2_INST[VA]_1 to S2_INST[VA]_2	Apparent power, CH2, Circuit 1-2	VA
	S3_INST[VA]_1	Apparent power, CH3	VA
	PF1_INST_1 to PF1_INST_2	Power factor, CH1, Circuit 1-2	
	PF2_INST_1 to PF2_INST_2	Power factor, CH2, Circuit 1-2	
PF3_INST_1	Power factor, CH3		

Classification	Data Header	Contents	Unit
Integrated power	Total integrated power from the start of time-series measurement		
	WP+_INTEG[Wh]_1 to WP+_INTEG[Wh]_4	Integrated active power (consumption), Circuit 1-4	Wh
	WP-_INTEG[Wh]_1 to WP-_INTEG[Wh]_4	Integrated active power (regeneration), Circuit 1-4	Wh
	WQ+_INTEG[varh]_1 to WQ+_INTEG[varh]_4	Integrated reactive power (lag), Circuit 1-4	varh
	WQ-_INTEG[varh]_1 to WQ-_INTEG[varh]_4	Integrated reactive power (lead), Circuit 1-4	varh
Demand	Integrated power within interval		
	WP+_INTVL[Wh]_1 to WP+_INTVL[Wh]_4	Integrated active power (consumption), Circuit 1-4	Wh
	WP-_INTVL[Wh]_1 to WP-_INTVL[Wh]_4	Integrated active power (regeneration), Circuit 1-4	Wh
	WQ+_INTVL[varh]_1 to WQ+_INTVL[varh]_4	Integrated reactive power (lag), Circuit 1-4	varh
	WQ-_INTVL[varh]_1 to WQ-_INTVL[varh]_4	Integrated reactive power (lead), Circuit 1-4	varh
	Average value within interval (demand value)		
	P_DEM[W]_1 to P_DEM[W]_4	Average value within time Active power (Consumption), Circuit 1-4	W
	Q_DEM[var]_1 to Q_DEM[var]_4	Average value within time Reactive power (LAG), Circuit 1-4	var
	PF_DEM_1 to PF_DEM_4	Average value within time, Power factor, Circuit 1-4 $\frac{P\_DEM}{\sqrt{P\_DEM^2+Q\_DEM^2}} *$	
	Maximum demand value during time-series measurement		
	P_DEM_MAX[W]_1 to P_DEM_MAX[W]_4	Maximum demand value, Active power, Circuit 1-4	W
P_DEM_MAX DATE_1 to P_DEM_MAX DATE_4	Date of occurrence of maximum demand yyyy/m/d, Circuit 1-4		
P_DEM_MAX TIME_1 to P_DEM_MAX TIME_4	Time of occurrence of maximum demand h:mm:ss, Circuit 1-4		

\*: If the regeneration power has only occurred during the interval, P\_DEM = 0 and PF\_DEM = 1.

## Reference

- "INST" in the header will be replaced by "AVE" for the average-value data.
- "INST" in the header will be replaced by "MAX" for the maximum-value data.
- "INST" in the header will be replaced by "MIN" for the minimum-value data.

**Memo**

**Memo**



- For regional contact information, please go to our website at <http://www.hioki.com>.
- The Declaration of Conformity for instruments that comply to CE mark requirements may be downloaded from the Hioki website.
- All reasonable care has been taken in the production of this manual, but if you find any points which are unclear or in error, please contact your supplier or the International Sales and Marketing Department at Hioki headquarters.
- In the interests of product development, the contents of this manual are subject to revision without prior notice.
- The content of this manual is protected by copyright.  
No reproduction, duplication or modification of the content is permitted without the authorization of Hioki E.E. Corporation.

# HIOKI

---

HIOKI E. E. CORPORATION

## Headquarters

81 Koizumi, Ueda, Nagano 386-1192, Japan  
TEL +81-268-28-0562 FAX +81-268-28-0568  
E-mail: [os-com@hioki.co.jp](mailto:os-com@hioki.co.jp)

**URL <http://www.hioki.com/>**

(International Sales and Marketing Department)

## HIOKI USA CORPORATION

E-mail: [hioki@hiokiusa.com](mailto:hioki@hiokiusa.com) URL <http://www.hiokiusa.com>

## HIOKI (Shanghai) Sales & Trading Co., Ltd.

E-mail: [info@hioki.com.cn](mailto:info@hioki.com.cn) URL <http://www.hioki.cn>

## HIOKI INDIA PRIVATE LIMITED

E-mail: [hioki@hioki.in](mailto:hioki@hioki.in) URL <http://www.hioki.in>

## HIOKI SINGAPORE PTE. LTD.

E-mail: [info@hioki.com.sg](mailto:info@hioki.com.sg)

1305