



## **MOM2** **MOM2 Win** Micro-ohmmeter

## **User guide**



# MOM2

# MOM2 Win

## Micro-ohmmeter

### NOTICE OF COPYRIGHT & PROPRIETARY RIGHTS

© 2013-2023, Megger Sweden AB. All rights reserved.

The contents of this manual are the property of Megger Sweden AB. No part of this work may be reproduced or transmitted in any form or by any means, except as permitted in written license agreement with Megger Sweden AB. Megger Sweden AB has made every reasonable attempt to ensure the completeness and accuracy of this document. However, the information contained in this manual is subject to change without notice, and does not represent a commitment on the part of Megger Sweden AB. Any attached hardware schematics and technical descriptions, or software listings that disclose source code, are for informational purposes only. Reproduction in whole or in part to create working hardware or software for other than Megger Sweden AB products is strictly prohibited, except as permitted by written license agreement with Megger Sweden AB.

### TRADEMARK NOTICES

Megger® and Programma® are trademarks registered in the U.S. and other countries. All other brand and product names mentioned in this document are trademarks or registered trademarks of their respective companies.

Megger Sweden AB is certified according to ISO 9001 and 14001.

#### Postal address:

Megger Sweden AB  
Box 724  
SE-182 17 DANDERYD  
SWEDEN

#### Visiting address:



Megger Sweden AB  
Rinkebyvägen 19  
SE-182 36 DANDERYD  
SWEDEN

T +46 8 510 195 00  
E seinfo@megger.com

[www.megger.com](http://www.megger.com)



# Contents

<b>1 Safety</b>	<b>6</b>	<b>5 Operating instructions</b>	<b>22</b>
1.1 Safety instructions	6	5.1 General instructions	22
1.2 Symbols on the instrument	7	Important regarding all testing	22
<b>2 Introduction</b>	<b>8</b>	<b>Power supply</b>	<b>22</b>
2.1 General	8	LCD display	22
Unpack system	8	To choose measurement time	22
2.2 Service and support	8	To choose $I > I_{min}$ or $I = I_{max}$	22
Training	8	Working at low temperatures	23
Contact information	8	Kelvin Clamp/Probe practice	23
2.3 Basic technical description	9	Save test results	23
Kelvin test	9	Hold present test result	23
2.4 DualGround – Both sides grounded	9	Delete present test result	23
<b>3 MOM2 overview</b>	<b>10</b>	Recalling test results from the log	23
3.1 The instrument	10	Delete results in the log	23
3.2 Included accessories	12	Delete all results in the log	23
3.3 Optional accessories	13	5.2 Measurement with max. charge, $I = I_{MAX}$	24
<b>4 Functions and set up</b>	<b>14</b>	5.3 Measurement with minimum current guarantee, $I > I_{min}$	25
4.1 General	14	5.4 Measurement using P/F – pass/fail	26
Internal software version	14	5.5 Measurement with user defined settings	27
4.2 Test positions	14	5.6 Measurement using the LOG function	27
4.3 Bluetooth – 	15	Running numbers mode	27
SET/ 	15	Circuit breaker testing mode	27
4.4 Clock – CLK	16	5.7 Measurement using P/F and $I_{min}$	29
SET/CLK	16	5.8 Testing on circuit breakers having a current transformer in the loop	30
4.5 Minimum current – $I_{min}$	17	5.9 Trouble shooting	30
SET/ $I_{min}$	17	Error messages	30
4.6 Data logger – LOG	17	<b>6 Application examples</b>	<b>32</b>
SET/LOG	17	6.1 Safety	32
4.7 Pass/Fail – P/F	18	Important regarding all testing	32
SET/P/F	18	6.2 Measurement using Kelvin probes	32
4.8 PC communication – PC COM	19	6.3 Test a CB using DualGround	33
PC COM	19	6.4 Test a CB by injecting through the ground cables	33
4.9 Audio signals	19	Disconnection	33
4.10 Battery power supply	20	<b>7 MOM2 Win</b>	<b>34</b>
Charging	20	7.1 Introduction	34
Battery practice	20	Download software	34
		7.2 MOM2 Win installation	34

---

Preconditions.....	34
Setup.....	34
Select language .....	34
7.3 Start MOM2 Win .....	35
Exit MOM2 Win.....	35
7.4 Connecting to MOM2.....	35
Automatic connecting .....	35
Manual connecting.....	35
7.5 Read the measurement log .....	37
Export data to file .....	38
Delete all data on the instrument.....	38
7.6 User settings.....	39
Read existing settings .....	39
Program "User" positions .....	39
7.7 Calibration.....	40
Procedure .....	40
Voltmeter calibration .....	40
Ammeter calibration .....	40
Calibration report .....	41
<b>8 Specifications</b> .....	<b>42</b>

# 1 Safety

## 1.1 Safety instructions

For your own safety and to get the maximum benefit from your instrument, please ensure that you read and understand the following safety instructions and warnings before using the instrument.



### Important

Read and comply with the following instructions.  
Always comply with local safety regulations.

### Warning

#### Connecting – before test

1. Before measuring resistance in circuit breakers or disconnecting switches (isolators), always check to see that the object being tested is closed and grounded at least on one side.
2. Do not connect the instrument to inductive loads if not necessary. This can cause high voltages when removing the current clamps and possibly damage MOM2.
3. Always connect the protective ground on MOM2 before making any other connections.
4. Always connect the test cables to MOM2 before connecting them to the test object.
5. Never connect MOM2 to live circuits.

#### During test

1. The rising current waveforms produced by the instrument may induce enough current into the secondary of a current transformer (CT) circuit to actuate a protective relay. If there is a CT in the current circuit, the protective relay equipment that is connected to it must be blocked to prevent actuation. After completing the measurements, you can follow the normal procedures that are used to demagnetize current transformer cores after DC has passed through their current transformer.
2. Never open a circuit breaker while MOM2 is connected to it.
3. Connection points for current cables can become hot during current generation.
4. High current on output terminals.

#### Disconnecting – after test

1. First, disconnect all test cables from the test object and then disconnect them from MOM2. Last, disconnect the protective ground from MOM2.

### Important

1. The instrument is intended for use in industrial environment. It generates, uses and can radiate radio frequency energy and, if not installed and used in accordance with these instructions it may cause interference to other devices in the vicinity. If this equipment does cause interference with other devices, which can be determined by turning the equipment off and on, the user is encouraged to try to correct the interference by one or more of the following measures:
  - Reorient or relocate the receiving device.
  - Increase the separation between the equipments.
  - Consult the manufacturer or field service technician for help.
2. Never leave the MOM2 unattended while it is turned on.
3. Do not use any accessories that are not intended for use together with the instrument.
4. It is not possible to use the MOM2 for testing during battery charging.
5. Use a damp cloth for cleaning. Do not use liquid cleaners or aerosol cleaners.
6. Do not attempt to service the instrument yourself. If you attempt to service the instrument yourself the warranty is no longer valid. Refer all servicing to Megger authorized personnel.
7. If you need to return the instrument, please use either the original crate or one of equivalent strength.

## 1.2 Symbols on the instrument



Caution, refer to accompanying documents.



Protective conductor terminal.



WEEE, Waste Electrical and Electronic Equipment. Please utilize your local WEEE collection facilities in the disposal of this product and otherwise observe all applicable requirements.



Equipment complies with current EU directives.

### Information duty regarding substances on REACH article 33, SVHC-list

This product contains a coin cell battery which contains 1,2- dimethoxyethane (CAS 110-71-4) above 0.1% by weight.

# 2 Introduction

## 2.1 General

The MOM2 is designed to measure the resistance of circuit breaker contacts, bus-bar joints, contact elements in bus-bars and other high-current links.

When contact resistance rises because of oxidation, loosened or improperly tightened threaded joints, temperatures rise abnormally at the points of contact. This abnormal heating reduces conductivity thereby accelerating the rise in temperature — and this often leads to serious trouble.

The MOM2 micro-ohmmeter can be used to detect such problems early so that they can be remedied long before trouble starts. Checking contact resistance at regular intervals provides a clear indication of the state of your system.

### Unpack system

Unpack the unit and check for evidence of any shipping damage. If there is any visual damage, immediately notify the freight carrier to make a damage claim, and notify Megger of the damage.

## 2.2 Service and support

For technical assistance please contact your local representative or direct your request to Megger in Sweden.

When sending the instrument, please use either the original crate or one of equivalent strength.

Add the return authorization number to the address label of the shipping container for proper identification and quicker handling.

**Note** *Ship the equipment without nonessential items such as test leads, etc. These items are not needed by the factory to perform service.*

### Training

For information about training courses contact your local distributor or the Megger Sweden office.

### Contact information

Internet: [www.megger.com](http://www.megger.com)  
 E-mail: [support-sweden@megger.com](mailto:support-sweden@megger.com)  
 Tel: +46 8 510 195 00



## 2.3 Basic technical description

The output current is delivered from a supercapacitor which is charged from the built-in rechargeable batteries.

### Kelvin test

The MOM2 uses Kelvin probes or clamps for the measurement. A Kelvin test uses four wires and measures continuity resistances ensuring all contact and lead resistances are compensated for, which allows a much greater accuracy in measurements. Each Kelvin probe assembly has two probe tips. When contacting the test object it will be contacted with two plus two probe tips. One pair is for the current generated. The other pair will measure the very small voltage present.

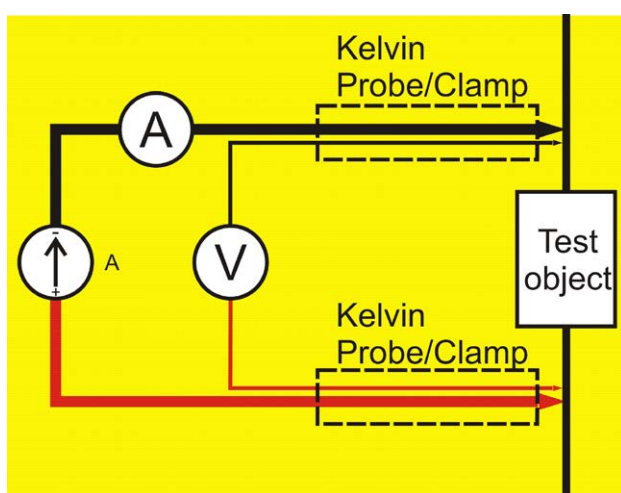

Principle for the 4 wire Kelvin test. Separate voltage sense cable can be used if necessary

## 2.4 DualGround – Both sides grounded

With MOM2 it is sometimes possible to make measurements according to the DualGround™ method. The ground resistance must be high enough to neglect the leak current through ground. The most important advantage is improved safety but the method is also easier and saves time. The number of tasks is reduced when the ground cable does not need to be disconnected and reconnected. Permission related work that may include paper work could many times be avoided. However, the local safety regulations shall always be followed.

Using the DualGround method might cause a small measurement error cause by the current running through the ground loop. The error value depends on the relation between the two parallel circuits.

**Example:** If the test object is  $50 \mu\Omega$  and ground loop is  $10 \text{ m}\Omega$  the error will be 0.5%

Two 10 m, 95 mm<sup>2</sup> grounding cables has a resistance of around 3.6 m $\Omega$ . Transitional resistance in connections and clamps to be added.

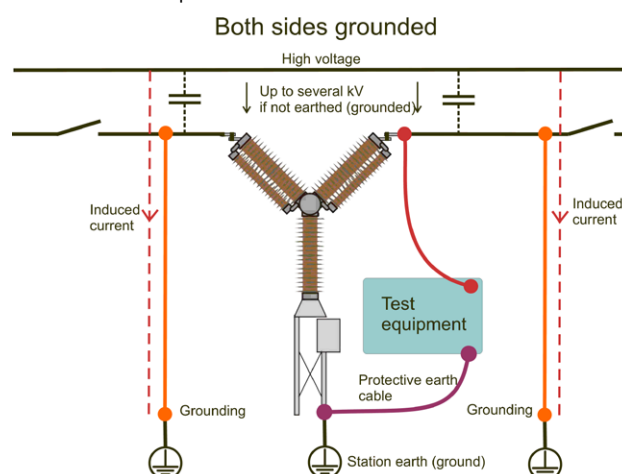

With both sides grounded the induced current will not pass through the test instrument.

# 3 MOM2 overview

## 3.1 The instrument

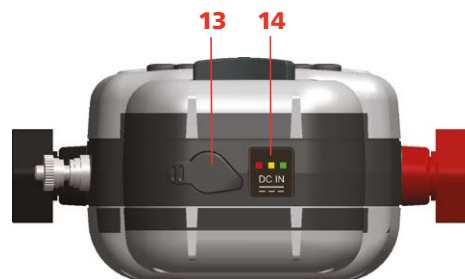
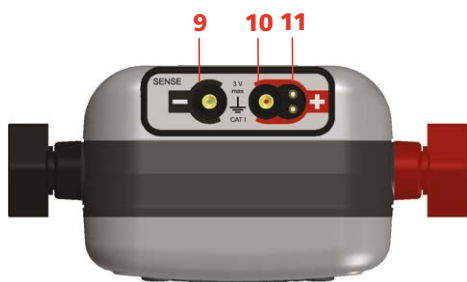
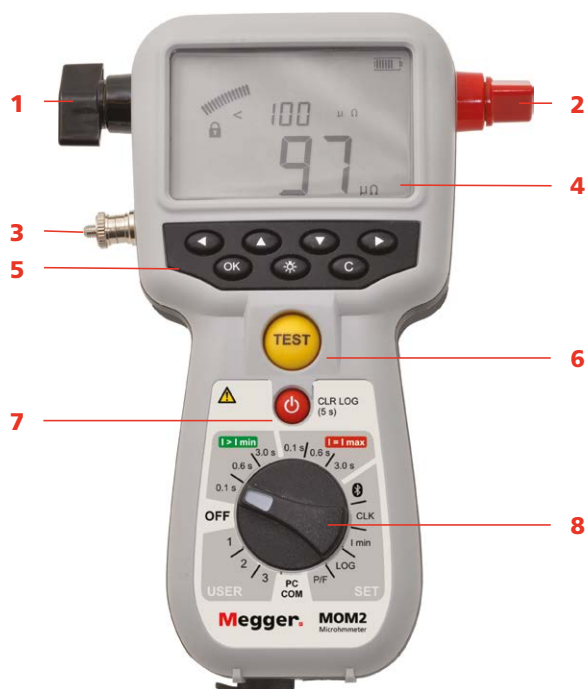



Top view

Bottom view

1.	<b>Current output terminal (-)</b>
2.	<b>Current output terminal (+)</b>
3.	<b>Protective conductor terminal</b>

4.	<h3>Display</h3> <ul style="list-style-type: none"> <li>■ The display offers a combination of analogue arc and a dual digital readout:</li> <li>■ Analogue arc: Shows the capacitor charge.</li> <li>■ Dual digital display: Large main digital readout for good visibility of all main measurement results Second digital display for additional data.</li> </ul>										
5.	<h3>Keys</h3> <p>Keys for navigation and to make settings in the display .</p> <table border="1"> <tr> <td>◀▶</td> <td>Left, right is used to navigate between characters/digits.</td> </tr> <tr> <td>▲▼</td> <td>Up, down is used to change each character/digit.</td> </tr> <tr> <td>OK</td> <td>Press and hold to enable edit of parameters select and confirm parameters. Press shortly to confirm.</td> </tr> <tr> <td>☀</td> <td>Backlight Automatic switch off after 20 s.</td> </tr> <tr> <td>C</td> <td>Clear / Cancel</td> </tr> </table>	◀▶	Left, right is used to navigate between characters/digits.	▲▼	Up, down is used to change each character/digit.	OK	Press and hold to enable edit of parameters select and confirm parameters. Press shortly to confirm.	☀	Backlight Automatic switch off after 20 s.	C	Clear / Cancel
◀▶	Left, right is used to navigate between characters/digits.										
▲▼	Up, down is used to change each character/digit.										
OK	Press and hold to enable edit of parameters select and confirm parameters. Press shortly to confirm.										
☀	Backlight Automatic switch off after 20 s.										
C	Clear / Cancel										
6.	<h3>TEST button</h3> <p>When the function selector is in any of the positions <b>I &gt; I min</b>, <b>I = I max</b> or <b>USER</b> measurement is performed by pressing the button.</p>										
7.	<h3>Stand-by / Wake up</h3> <p>Press shortly to toggle</p> <h3>Clear log</h3> <p>(Press and hold for 5 s)</p>										

8.	<h3>Function selector</h3> <table border="1"> <tr> <td colspan="2"><b>OFF</b></td> <td></td> </tr> <tr> <td rowspan="3"><b>I &gt; I min</b></td> <td><b>0.1 s</b></td> <td>Test positions</td> </tr> <tr> <td><b>0.6 s</b></td> <td rowspan="2">Measurement time with minimum current guarantee</td> </tr> <tr> <td><b>3 s</b></td> </tr> <tr> <td rowspan="3"><b>I = I max</b></td> <td><b>0.1 s</b></td> <td>Test positions</td> </tr> <tr> <td><b>0.6 s</b></td> <td rowspan="2">Measurement time with max. charge</td> </tr> <tr> <td><b>3 s</b></td> </tr> <tr> <td rowspan="6"><b>SET</b></td> <td></td> <td>Bluetooth "pair units"</td> </tr> <tr> <td><b>CLK</b></td> <td> <ul style="list-style-type: none"> <li>■ Set date and time</li> <li>■ Set volume for the internal buzzer</li> <li>■ Discharge the MOM2 internal capacitor</li> </ul> </td> </tr> <tr> <td><b>I min</b></td> <td>Minimum current guarantee setting</td> </tr> <tr> <td><b>LOG</b></td> <td>Data log settings</td> </tr> <tr> <td><b>P/F</b></td> <td>Pass/Fail settings</td> </tr> <tr> <td><b>PC COM</b></td> <td colspan="2">PC communication (dump data to PC)</td> </tr> <tr> <td rowspan="3"><b>USER</b></td> <td><b>1</b></td> <td>Test positions</td> </tr> <tr> <td><b>2</b></td> <td rowspan="2">Stored settings (Set from PC SW)</td> </tr> <tr> <td><b>3</b></td> </tr> </table>	<b>OFF</b>			<b>I &gt; I min</b>	<b>0.1 s</b>	Test positions	<b>0.6 s</b>	Measurement time with minimum current guarantee	<b>3 s</b>	<b>I = I max</b>	<b>0.1 s</b>	Test positions	<b>0.6 s</b>	Measurement time with max. charge	<b>3 s</b>	<b>SET</b>		Bluetooth "pair units"	<b>CLK</b>	<ul style="list-style-type: none"> <li>■ Set date and time</li> <li>■ Set volume for the internal buzzer</li> <li>■ Discharge the MOM2 internal capacitor</li> </ul>	<b>I min</b>	Minimum current guarantee setting	<b>LOG</b>	Data log settings	<b>P/F</b>	Pass/Fail settings	<b>PC COM</b>	PC communication (dump data to PC)		<b>USER</b>	<b>1</b>	Test positions	<b>2</b>	Stored settings (Set from PC SW)	<b>3</b>
<b>OFF</b>																																				
<b>I &gt; I min</b>	<b>0.1 s</b>	Test positions																																		
	<b>0.6 s</b>	Measurement time with minimum current guarantee																																		
	<b>3 s</b>																																			
<b>I = I max</b>	<b>0.1 s</b>	Test positions																																		
	<b>0.6 s</b>	Measurement time with max. charge																																		
	<b>3 s</b>																																			
<b>SET</b>		Bluetooth "pair units"																																		
	<b>CLK</b>	<ul style="list-style-type: none"> <li>■ Set date and time</li> <li>■ Set volume for the internal buzzer</li> <li>■ Discharge the MOM2 internal capacitor</li> </ul>																																		
	<b>I min</b>	Minimum current guarantee setting																																		
	<b>LOG</b>	Data log settings																																		
	<b>P/F</b>	Pass/Fail settings																																		
	<b>PC COM</b>	PC communication (dump data to PC)																																		
<b>USER</b>	<b>1</b>	Test positions																																		
	<b>2</b>	Stored settings (Set from PC SW)																																		
	<b>3</b>																																			
9.	<h3>Input for sensing voltage (-)</h3> <p>Connector for the negative test lead.</p>																																			
10.	<h3>Input for sensing voltage (+)</h3>																																			
11.	<h3>Connector for trigger</h3>																																			
12.	<h3>Battery lid</h3>																																			
13.	<h3>Connector for the battery charger</h3>																																			
14.	<h3>Battery charging indicator</h3>																																			

### 3.2 Included accessories



Test cables with Kelvin probes (included. in BD-59090)



Test cables with Kelvin clamps (included. in BD-59092)



Transport case with MOM2 and included accessories.

#### Other included accessories

- Charger
- Rubber holster
- Carrying strap
- Belt clip
- PC Software MOM2 Win

### 3.3 Optional accessories



Cable kit 5 m (16 ft), (GA-00380)



Soft carrying case, (6380-138)



# 4 Functions and set up

## 4.1 General

### Internal software version

When turning the function selector from OFF to any position the display will shortly show a number e.g. 008 and then during five seconds the internal software version e.g. "01C" (revision R01C).



### OFF

The instrument should be in the **OFF** position when not in use.

**Note** *The MOM2 will go to stand by mode after about 10 minutes of inactivity. To wake up, press Stand-by / Wake up (CLR LOG) button.*

## 4.2 Test positions

### I > I min

Minimum current is set in position **SET / I min**.  
Generation/measurement time: 0.1 s, 0.6 s or 3 s.

### I = I max

The current is only limited by the total impedance of the circuit.  
Generation/measurement time: 0.1 s, 0.6 s or 3 s.

### USER / 1, 2, 3

User defined settings as generation time, I min, pass/fail and log.

**Note** *The user defined settings can only be set via MOM2 Win from a PC*

## 4.3 Bluetooth –

Megger do not sell Bluetooth headset. However, bluetooth headsets can be used with MOM2. Follow instruction below.

### SET /

#### Display abbreviations

SEt	Set
SPC	Set-up PC
SHS	Set-up headset
Prd	Paired
E-d	Enable / Disable (headset)
EnA	Enabled (headset)
diS	Disabled (headset)
o	Processing
ErA	Erase all addresses

#### Enable / Disable Bluetooth

- 1] Use the ◀ ▶ keys to find "E-d".
- 2] Press OK to toggle between "EnA" (Enabled) and "diS" (Disabled).

**Note** *Do not use the PC COM mode if there is a requirement for non-electromagnetic interference in the environment. The PC COM position is always enabled as it overrides the disable setting.*



#### Set up Bluetooth

- 1] Select SET /  on the MOM2.



- 2] Press ▶, "SPC" will be shown.
- 3] Press "OK". Display will show "o". The MOM2 is now visible in the Bluetooth network and ready to be paired.
- 4] Open up the Control Panel on the PC.
- 5] Select "Add a device" from the control panel. The computer searches for MOM2 and after a while the MOM2 device is found.
- 6] Select the MOM2 item and press "Next". After this, a menu appears that asks for the passcode.
- 7] Enter code 0000 and press Next.

The installation now takes place and installation gets finished. Display on MOM2 shows "Prd" and setup is complete.

- 8] Check also the device manager and double click on  Bluetooth and check that the  Megger MOM2 comes up in the list.
- 9] Check that the MOM2 Win can communicate with the MOM2.
- 10] Turn the function selector to the PC COM position on the MOM2 panel.
- 11] Start the MOM2 Wi. The software shall now read out the s/n on the MOM2 and the connected port.

**Note** *The procedure to pair and assign com port varies depending on the equipment.*

#### How to pair a headset

- 1] Select SET /  on the MOM2.
- 2] Use the ◀ ▶ keys to find out that Bluetooth is enabled, "EnA".
- 3] Press right arrow key twice. The display shows "SHS".
- 4] Set the headset in pair mode (See the instructions for the headset.)
- 5] Press the OK key on the MOM2.
- 6] When the display shows "Prd" the pairing is ready.

#### How to start the headset

- 1] See the instructions for the headset

## 4.4 Clock – CLK

### SET/CLK

There are three functions in this position:

- A]** Set date and time.
- B]** Set volume for the internal buzzer.
- C]** Discharge the MOM2 internal capacitor, (used for service only).

- 4]** Set level (1 to 5) using the ▲▼ keys.
- 5]** Press OK key.
- 6]** Press ► or ◀ to return.

### Display abbreviations

CLC	Clock
UOL	Volume
dIS	Discharge (used for service only)
yy	Year
non	Month
dd	Day
HH	Hour
nIn	Minute

### Date and time

- 1]** Select SET/CLK



- 2]** Press and hold OK key until digits start to blink under the "yy" letters.



- 3]** Set year using the ▲▼ keys.
- 4]** Press OK key.
- 5]** Press the ► key to go further and set month, day, hour and minute in the same way as above.
- 6]** Press C key to return.

### Volume for buzzer

- 1]** Select SET/CLK
- 2]** Press ► key, "UOL" is shown.
- 3]** Press and hold OK key until digit start to blink.



## 4.5 Minimum current – I min

### SET / I min

#### Display abbreviations

SEL	Select
-----	--------

#### Set-up

- 1] Select **SET / I min**. Present setting is displayed.
- 2] Press and hold OK key until digits start to blink under the "SEL" letters.
- 3] Select value, 50 or 100, using the ▲ ▼ keys.



- 4] Press OK key to confirm.  
To cancel press C key or turn the function selector to another position.

#### Result after a measurement

If the chosen value is not reached during a measurement it will result in a notification on the display and by an audio signal.



Picture shows an example after a measurement. The I min limit "50 A" has not been achieved, indicated by the "<" character to the left.

The current measured during the test is shown in the upper row. The value shown toggles between the max and min current during the test. In this case it is the minimum current showing "> 037 A".

## 4.6 Data logger – LOG

The data memory can store totally 180 (Running numbers mode) measurements and this capacity is shared by the two log modes.

### SET / LOG

#### Display abbreviations / description

SEL	Select
oFF	OFF
1A1	Label for Breaker, Phase, Interrupter
1234	Running numbers

#### LOG modes

##### OFF



When the log is OFF only the latest value is stored and only until the performance of a following measurement, which overwrites the previous one.

##### Circuit breaker testing mode, 1A1



This mode is primarily designed for measurement on circuit breakers. The three characters (1A1) are supposed to indicate: Breaker, Phase, Interrupter.

Measurement is automatically stored. Each label can store three measurements. See also section 5.6 Measurement using the log function.

##### Running numbers mode, 1234



The measurements are numbered in numerical order. Measurement is automatically stored, provided that the memory is not full.

**Set-up**

- 1] Select **SET/LOG**. Present setting is displayed.
- 2] Press and hold **OK** key until characters start to blink under the "SEL" letters.
- 3] Use the **▲ ▼** keys to select mode.
- 4] Press **OK** key.

**4.7 Pass/Fail – P/F**

In the P/F position you can enable and set the limit for the Pass/Fail function. If the measured value exceeds the set limit it will result in a notification on the display and by an audio signal

**SET/P/F****Display abbreviations**

SEL	Select
oFF	OFF

**Set-up**

- 1] Select **SET/P/F**. Present setting is displayed.
- 2] Press and hold **OK** key until character, "<" or "oFF" start to blink.



- 3] Select "oFF" or a value using the **▲ ▼** keys.
- 4] Use the keys **▶ ◀** to select the digit to change, it will blink.
- 5] Use the keys **▲ ▼** keys to set the desired value.
- 6] Press **OK** key.  
To cancel press **C** key or turn the function selector to another position.

## 4.8 PC communication – PC COM

The PC COM position is used for all operations performed from a PC using MOM2 Win. You can:

- Dump measurement data from the MOM2
- Delete all measurements in the data log
- Program "User" positions
- Set MOM2 clock
- Calibrate

### PC COM

#### Display abbreviations

rEn	Remote
-----	--------















#### Set-up

The following is needed:

- A PC with MOM2 Win installed  
See chapter 8 MOM2 Win
- A PC connected via Bluetooth  
See section "Bluetooth set up"

## 4.9 Audio signals

The MOM2 emits different sounds to give an audible information / confirmation of an event / action. The sound is emitted from a built-in buzzer and from the Bluetooth headset (optional). The audio signals vary in frequency, Low / High, and composition.

Audio signals	Description
	The MOM2 is charging the capacitor and is not ready for measurement.
	Battery low During capacitor charge
	Measurement in progress
	Pass signal Measurement complete / Pass Wake up
	Fail signal Measurement complete / Fail Label full Stand-by
	When pressing Test/Trigger while lock symbol is shown
	Delete confirmed When press and hold the Test/Trigger Note: Only in LOG mode
	Hold When pressing Test/Trigger Note: Only in LOG mode
	Release When pressing Test/Trigger Note: Only in LOG mode
<b>Legend</b>	 Short - High tone
	 Long - High tone
	 Short - Low tone
	 Long - Low tone
	 Continuous

## 4.10 Battery power supply

### Charging

Before using the MOM2 the batteries should be charged. Use the supplied charger and connect it to the socket at the bottom of the MOM2. Typical recharge time for fully discharged batteries is 3 hours, at 25°C (77°F).

**Tip** Place the MOM2 upside down to get better the cooling of the batteries.

### Important

MOM2 cannot be used for testing during charging.



LED indicator	Description	Clarification / Remedy
Green	Fully charged	
Yellow Green	Charging	
Red Yellow Green	Temperature limits exceeded during the charging.	Charging will restart when temperature has decreased.
Red Green	Temperature limits exceeded, too high or too low, before charging.	Charging will start when temperature is within the limits.
Red	Fault state. Wrong battery type, faulty battery.	Disconnect the charger and check the batteries.
None	Battery fault / missing or other fault	Check batteries and charger / cables

### Replacing the batteries

1] Loosen the two screws that holds the battery plate at the back of MOM2, see figure below.

It is recommended to use the same type of batteries (AA (HR6) 2500 mAh NiMH) as the original ones.

**Note** It is possible to use standard (non-rechargeable) alkaline cells but then only for test using the 0.1 s measurement position and  $I > 1$  min.



Loosen the two screws that holds the battery lid at the back of MOM2.

### Important

Always replace all batteries at the same time.

Do not mix old and new batteries.

Do not mix types or brands.

### Battery practice

- To extend the battery life cycle time it is a good practice to recondition the batteries in a separate charger that has recondition options like refresh / discharge. It is a good idea to condition the batteries once in about 6 months or after around 12 regular charge cycles to get the most out of them. Prior storage, charge the batteries.
- To prevent the batteries from becoming fully discharged, if MOM2 is not used regularly, a good rule of thumb is to charge the batteries every month.

**Note:** *If the batteries are fully discharged it will be impossible to charge them in the MOM2. However, a separate battery charger may be able to charge the batteries.*

---

# 5 Operating instructions

## 5.1 General instructions

### Important regarding all testing



**Important** Read and comply with the safety instructions. Always comply with local safety regulations.

### Power supply

Prepare testing by charging the batteries see section 4.10 Battery power supply.

**Note** *The MOM2 cannot be used for testing during battery charging.*

### LCD display

The display can be backlighted by pressing the key . It is switched off automatically after 20 seconds.

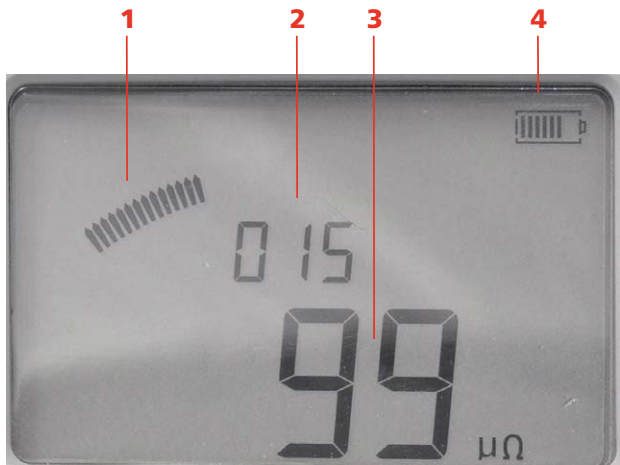

- |    |  |
|----|--|
| 1. | <b>Analogue arc</b><br>Indicates level of the capacitor charge                                   |
| 2. | <b>Measurement label</b><br>In this case the instrument is set in Running numbers mode (SET/LOG) |
| 3. | <b>Measurement result</b>  |
| 4. | <b>Battery charge indicator</b>  |

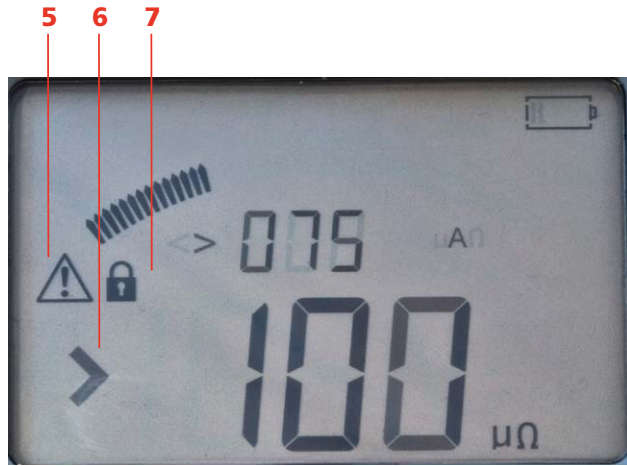

- |    |  |
|----|--|
| 5. | <b>Warning</b><br>See section 5.8 Troubleshooting  |
| 6. | <b>Pass/Fail indicator</b><br>In this case the Pass/Fail is set to 100 μΩ  |
| 7. | <b>Padlock symbol</b><br>The lock symbol is shown when the capacitor is charged prior to a test and when you lock a test result. |

### To choose measurement time

In an environment without electrical interference it is wise to choose the shortest measurement time, which means that you can get the largest number of measurements on a single battery charge.

**Note** *The shortest measurement time (0.1 s) is not suitable in environments with a frequency of 16 2/3 Hz.*

 **Tip:** Start making three tests with the shortest measurement time to figure out if the results vary. If they do not differ significantly - use 0.1 s for the tests.

### To choose I > I min or I = I max

If you want maximum current for the test, choose **I = I max**. The capacitor will be charged to its maximum and requires much energy from the batteries. If lower current is sufficient for the measurement, it is advisable to use the **I > I min** position. In the

**SET/I min** position you select the minimum current to be 50 A or 100 A.

Min current guarantee (I > I min)	Max current (I = I max)
Suitable for test objects $\leq 2 \text{ m}\Omega$	Recommended for test objects $> 2 \text{ m}\Omega$
Capacitor only charged to sufficient level to generate selected minimum current for set time Saves instrument battery	Capacitor is fully charged Will push as much current as possible through the test object for set time. Current is determined as: $I \approx 2.5 \text{ V} / [\text{test object } R + 0.01 \Omega] \text{ A}$
Allows for shorter time between tests	Requires longer capacitor recharge times

**Note** *If you get varying measurement results using the I > I min position, change to I = I max.*

## Working at low temperatures

MOM2 can be operated down to  $-20^\circ\text{C}$  provided that the batteries keep a temperature over  $0^\circ\text{C}$ . When the instrument is in use the batteries will generate heat enough to keep themselves warm.

## Kelvin Clamp/Probe practice

### Important

To avoid adding unwanted transition resistances to the measurement result the Kelvin clamps or Kelvin probes shall be connected directly to the test object and not to e.g. a bolt head.

In some cases it might be advisable to use separate sense cables, forming a conventional four point measurement, in order to get a more accurate voltage sense.

## Save test results

**A]** When **LOG** is activated measurement results are automatically saved in the memory.

**B]** When the log is OFF only the latest value is stored and only until the performance of a following measurement, which overwrites the previous one.

## Hold present test result

When the LOG function is activated the measurement result is shown on the display for about 3 seconds. After that it is stored in the memory. If you want to study the result longer you can lock the display view by doing as follows.

**1]** Press shortly the trigger on the Kelvin probe or the **TEST** button just after a measurement. The latest test result is locked and shown on the display. This is confirmed by a padlock symbol on the display and an audio signal.

**2]** To unlock, press shortly the trigger on the Kelvin probe or the **TEST** button.

## Delete present test result

**1]** Press and hold, about 1 s, the trigger on the Kelvin probe or the **TEST** button just after a measurement.

The latest test result is deleted from screen and log. This is also confirmed by an audio signal.

**Note** *This is also possible to carry out when the result is locked on display.*

## Recalling test results from the log

**1]** Saved results can be recalled by scrolling to desired label using the **▲ ▼ ◀ ▶** keys.

## Delete results in the log

**1]** Select label using the **▲ ▼ ◀ ▶** keys.

**2]** By pressing the **C** key the display will prompt "CLR" in big characters.

**3]** Delete by pressing the **OK** key. Cancel can be done by pressing the **C** key.

**Note** *In Circuit breaker testing mode the measurement results will be deleted one at a time.*

## Delete all results in the log

**1]** Press and hold, for 5 s, the red button below the **TEST** button.

**Note** *This will delete the log memory for both log modes, Circuit breaker testing and Running numbers.*

## 5.2 Measurement with max. charge, I=I MAX

- 1] Read the section 5.1 General instructions.
- 2] If applicable, connect the ground cable (protective earth).
- 3] Make the desired settings in the SET options. In this example LOG and P/F are disabled (set to OFF).
- 4] Attach the test cables.
- 5] Turn the function selector to desired I=I max position.  
The instrument indicates that it is charging the capacitor by a repeated sound and on the display shows alternating "CAP" and "CHG" and the lock symbol.



Charging

- 6] The MOM2 is ready for a measurement when the lock symbol disappears.

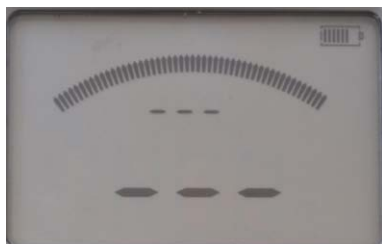

Ready for test

- 7] Press the TEST button on MOM2 or the pull the trigger on the probe.  
A continuous audio signal tells that the measurement is in progress.  
Two short signals tells that the measurement is complete.
- 8] The result is shown on the display, see figures below.  
Over the resistance value "100 μΩ" toggles the maximal and minimal current values during the test. "268 A" and "250 A"



Pictures shows the two display views..



## 5.3 Measurement with minimum current guarantee, $I > I_{min}$

- 1] Read the section 5.1 General instructions.
- 2] If applicable, connect the ground cable (protective earth).
- 3] Make the desired settings in the SET options. Select  $I_{min}$  to 50 or 100 A (in this example set to 100 A).  
In this example **LOG** and **P/F** are disabled (set to OFF).
- 4] Attach the test cables.
- 5] Turn the function selector to desired  $I > I_{min}$  position.  
The instrument indicates that it is charging the capacitor by a repeated sound and on the display shows alternating "CAP" and "CHG" as well as the padlock symbol.



Charging

- 6] When the lock symbol disappears the MOM2 is ready for a measurement.

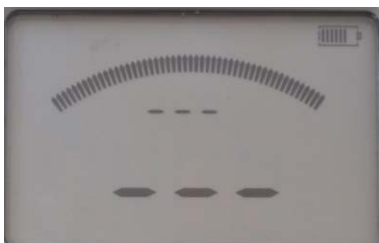

Ready for test

- 7] Press the **TEST** button on MOM2 or **Trigger** on the probe.  
A continuous audio signal tells that the measurement is in progress.  
Two short signals tells that the measurement is complete.

- A] If the current value is over the set min current limit the result will be shown on the display with big digits.  
The small digits toggle between max and min current value.



Pictures shows that the test current was below 219 A and over 205 A.

- B] If the current value is below the set min current limit there is the fail signal and the < character is displayed to the left of the set min current value.



Picture shows that the test current was below 100 A.

## 5.4 Measurement using P/F – pass/fail

- 1] Make the desired settings in the **SET** options  
 Select **P/F** and enter desired limit value.  
 In this example **LOG** is set to OFF
  - 2] Turn the function selector to one of the test positions.
  - 3] Press the **TEST** button on MOM2 or the **pull** the trigger on the probe.  
 A continuous audio signal tells that the measurement is in progress.  
 Another signal tells that the measurement is complete, pass or fail.
- A]** If the resistance value is below the **P/F** limit.  
 The result will be shown on the display with big digits.  
 The small digits toggle between the **P/F** limit and the max, min current values.



The small digits show the set P/F value (< 90 μΩ).  
 The character ">" to the left of the big digits indicates that the P/F value was exceeded.



The minimum current was 80 A and the resistance value is 102 μΩ.



Here P/F limit was set to 150 μΩ and the measured resistance value is 100 μΩ.



Max current during test was 219 A.



Min current during test was 205 A

- B]** If the resistance value is over the **P/F** limit there is the fail signal and the > character is displayed to the left of the set **P/F** value.

## 5.5 Measurement with user defined settings

There are three positions for storing user defined settings. These can only be set via a PC with the MOM2 Win Software, see chapter MOM2 Win.

## 5.6 Measurement using the LOG function

See section 4.6 Data logger – LOG for how to set up.

### Running numbers mode

The measurements are numbered in numerical order 1 to 1999

Measurement is automatically stored, provided that the memory is not full (Running numbers =1999).



The display before first measurement.

### The display after measurements

By using the ◀▶ and ▲▼ keys you can scroll between the saved test results.

**Note** *You can only scroll through the measurements in the selected LOG mode*

### Circuit breaker testing mode

Each label e.g. **1A1** in the memory for the circuit breaker measurement can contain three measurements. These are indicated by commas, see picture below.

#### The label is built of three elements

- Two-digit indication of circuit breaker (1 to 19)
- A letter for phase (A,B,C)
- Digit for interrupter (1 to 9)

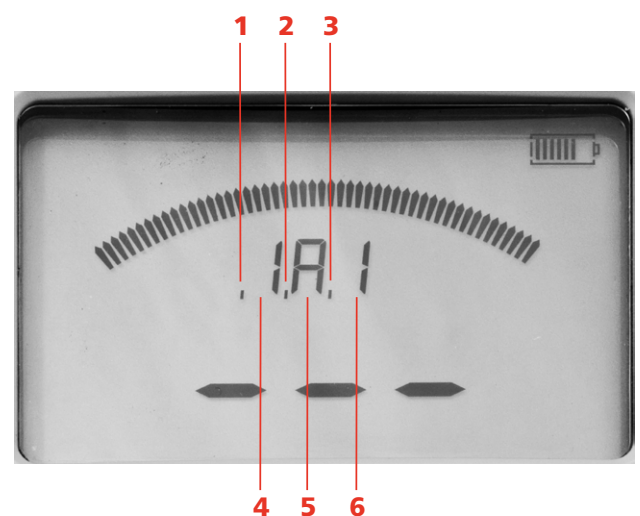

1. The first measurement on the present label shown by a comma.

2.	The second measurement in the present memory cell shown by a comma.
3.	The third measurement in the present memory cell shown by a comma.
4.	Digit for the circuit breaker
5.	Letter for the phase
6.	Digit for the interrupter

**To view all measurements stored on the same label**

- 1] Press the ▲ ▼ keys until an arrow sign is shown to the left.
- 2] Scroll between measurements 1, 2 and 3 by using the ◀ ▶ keys.  
Example: Three measurements on one label are shown as e.g. "1A1-1", "1A1-2", "1A1-3".

**Note** *You can only scroll through the measurements in the selected LOG mode*

**The display before measurement**



The display before first measurement, one comma:



The display before second measurement, two commas:



The display before third measurement; three commas.

**The display after measurements**

When three measurements have been done and saved to a label e.g. **1A1** the lock sign is shown.

**Note** *To continue to measure you need to either delete the latest measurement or scroll to a blank label.*

By using the ◀ ▶ and ▲ ▼ keys you can toggle between the saved test results



The display shows "3" for the third measurement for the specific label. The arrow sign to the left only represents the omitted characters to the left of the digit "3".

## 5.7 Measurement using P/F and I min

In this example **LOG** is set to OFF.

- 1] Read the section 5.1 General instructions.
- 2] If applicable, connect the ground cable (protective earth).
- 3] Make the desired settings in the SET options. Select **P/F** and enter desired limit value. Select **I min** (50 or 100 A).
- 4] Attach the test cables.
- 5] Turn the function selector to desired **I > I min** position.  
The instrument indicates that it is charging the capacitor by a repeated sound and on the display shows alternating "CAP" and "CHG" as well as the padlock symbol.



Charging

- 6] When the lock symbol disappears the MOM2 is ready for a measurement.

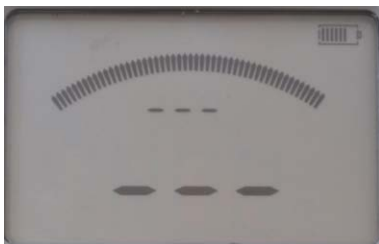

Ready for test

- 7] Press the **TEST** button on MOM2 or pull the trigger on the probe.  
A continuous audio signal tells that the measurement is in progress.  
When the measurement is complete there will be a pass or a fail signal.
- A]** If the resistance value is below the **P/F** limit and the current value is over the set min current limit the result will be shown on the

display with big digits e.g. as below.  
The small digits toggle between max and min current value and the **P/F** limit.



The minimum test current was 80 A and resistance is 102 μΩ.

**B]** If the resistance value is over the **P/F** limit there is the fail signal and the > character is displayed to the left of the set **P/F** value.



The small digits show the set **P/F** value (< 90 μΩ).  
The character ">" to the left of the big digits indicates that the **P/F** value was exceeded.

**C]** If the current value is below the set min current limit there is the fail signal and the < character is displayed to the left of the set min current value.



The maximum test current was 82 A and the test current was below 100 A.

**D]** If both the **P/F** limit and the current limit are contravened, the big digits will toggle between resistance value, < current limit and > **P/F** limit.

## 5.8 Testing on circuit breakers having a current transformer in the loop

If there is a current transformer (CT) in series with the breaker contact to be tested then it is advisable to make some basic checks.

Encapsulated or dead tank breakers are the most common types which have a current transformer in the loop.

The technical reason is that the CT must be saturated before it is possible to get a reliable result. To get a transformer saturated it needs time and current or an open secondary winding.

A CT included in the circuit may influence the DC resistance reading. The CT need to be in saturation not to influence the DC resistance measurement. The time required to drive the CT in saturation depends on current level and secondary side burden, the time is usually several seconds if secondary side is shorted.

If possible make a visual check to be sure that there is no current transformer in the loop. If this is not possible like in encapsulated breakers then make the following check:

- 1] Make two tests, one with 0.1 second and one with 3 seconds setting. If the values are equal then there is no current transformer in the loop.**

If you get different readings it might be a need for a "workaround".

- 1] If possible increase the current and / or test time.**
- 2] Increase the burden on the current transformer by connecting a 5 to 10 ohm resistor across the winding.**
- 3] Repeat the measurement several times in the same direction until a stable value is achieved.**

## 5.9 Trouble shooting

Problem	Solution
Headset does not work	Check that it is paired to MOM2
	Check on MOM2 that Bluetooth is enabled
Impossible to charge the batteries with the supplied charger in MOM2	Please see information under section "Battery practice" on page <?>.

### Error messages

Message	Cause	Remedy
"OL"	Bad connection / resistance out of measurement range	Check cables and connections
Warning sign on display and the battery charge indicator blinks	The batteries cannot charge the capacitor	Charge the batteries Note: It might be possible to proceed and make some tests if it is realistic to select a test position that requires less power (shorter measuring time).
Warning sign on display	A thermal protection has tripped.	Turn off the MOM2 and let it cool down.





# 6 Application examples

## 6.1 Safety

### Important regarding all testing



**Important**

**Read and comply with the safety instructions.**  
**Always comply with local safety regulations.**

**Note** *If you are measuring resistance in a circuit breaker or disconnecting switch (isolator), make sure that it is closed and grounded at both sides before testing.*

## 6.2 Measurement using Kelvin probes

An example how to perform testing using the two Kelvin probes. This example describes the performance if you only want to know if the test object pass a preset value and you do not need to store the test results.

- 1] Select **LOG** function "OFF", and set **P/F** value (see section 4.6 and 4.7).
- 2] Attach the test cables with Kelvin probes (2 x 1.3 m) one with a trigger, to MOM2.
- 3] Turn the function selector to desired position.
- 4] Hook the instrument to your belt or use the strap.
- 5] Press and hold the two Kelvin probes to the test object and pull the trigger.  
 If the value is outside the limits there is a sound telling the result was fail.  
 The measurement value remains until another measurement is performed or until the instrument is switched off.



*Measurement on a test object*



## 6.3 Test a CB using DualGround

You can perform testing with both sides grounded. However the measurement accuracy will be somewhat lower with both sides grounded depending on the ratio of the currents – circuit breaker / grounding cables (see section 2.4). This example shows a test on a HV CB using a man lift.

- 1] The circuit breaker shall be disconnected, closed and grounded on both sides.
- 2] Attach the black (3 m) test cable with Kelvin clamp and the Kelvin probe with trigger to the instrument.
- 3] Hook the MOM2 to your belt or use the strap to hang it around your neck.
- 4] Attach the black test cable with Kelvin clamp to one side of the CB using the man lift.
- 5] Move yourself to the other side of the CB using the manlift.
- 6] Press and hold the Kelvin probe to the test object and pull the trigger.

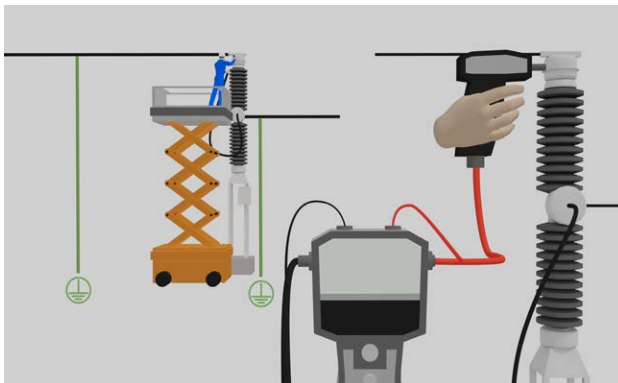

Measurement on circuit breaker with both sides grounded.

**Note** The test can also be done by using two Kelvin clamps.

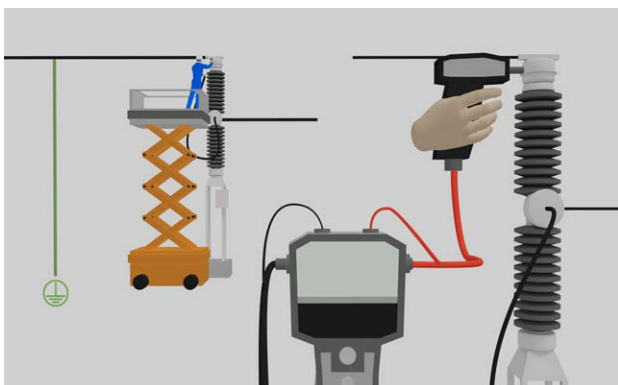

This measurement can be done with one side grounded.

## 6.4 Test a CB by injecting through the ground cables

- 1] The circuit breaker (CB) shall be disconnected, closed and grounded on both sides.
- 2] Connect the MOM2 to ground.
- 3] Attach an extra ground cable (not included) with at least 95 mm<sup>2</sup> cross section area to one side of the CB.
- 4] Connect the 0.5 m current cable to the current out minus terminal on the MOM2 and attach the other end to ground close to where the CB's grounding cable is attached. (the opposite side of CB from where the extra ground cable is attached).
- 5] Mount the 0.1 m plate to the current out plus terminal on the MOM2 and attach the extra ground cable to the plate.
- 6] Connect the sensing cables (red and black) to the CB.
- 7] Remove the original CB grounding cable on the side where the extra grounding cable is attached.
- 8] Press the **TEST** button.

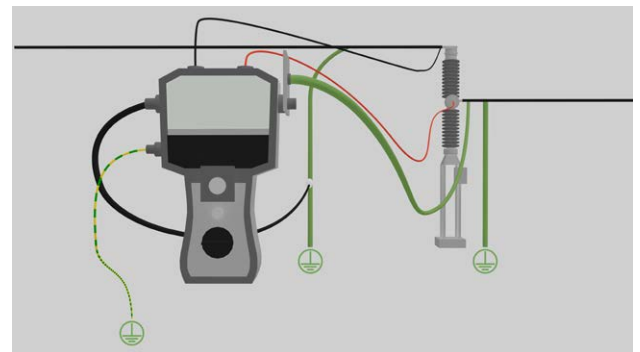

Traditional measurement from ground. Injection is done through existing grounding cable (earthing). Optional cable kit is needed. Available kits have 5, 10 or 15 m cables.

### Disconnection

- 1] Re-attach the original CB grounding on the side where the extra grounding is attached.
- 2] Disconnect the sensing cables from the CB.
- 3] Disconnect the extra ground cable from the 0.1 m plate on plus terminal.
- 4] Disconnect the 0.5 m current cable from ground.
- 5] Disconnect the ground cable from MOM2.

# 7 MOM2 Win

## 7.1 Introduction

MOM2 Win is a Windows® program that communicates with the MOM2 micro-ohmmeter instrument.

It is used for:

- Reading measurement data from the instrument and save it to file
- Configuring the instrument
- Calibrating the instrument

## Download software

- 1] Go to the megger web site:  
[www.megger.com](http://www.megger.com) and search for MOM2.

## 7.2 MOM2 Win installation

### Preconditions

- Windows XP / 7 / 10
- Computer with built in bluetooth or using USB Bluetooth dongle.
- USB Bluetooth dongle  
The USB Bluetooth dongle must be installed, see the installation instructions supplied with the dongle.

### Setup

- 1] Insert the USB stick with the MOM2 Win sw. Select and run the file "Setup.exe" to install the program.

The program will be installed in the folder C:\Program Files (x86)\Programma\MOM2 Win with program shortcuts on the desktop.

### Select language

- 1] Under "Settings" menu, select "Language". All texts in all open windows will be updated with the selected language.

**Note** *If the translation is missing for some texts the default language (English) will be used.*

*The language selection does not change the time format or decimal separator which instead follows the Windows regional settings.*

## 7.3 Start MOM2 Win

- 1] Click the MOM2 icon on the desktop or run the file Mom2Win C:\Program Files (x86)\Programma\MOM2 Win  
The program will startup showing the start page.

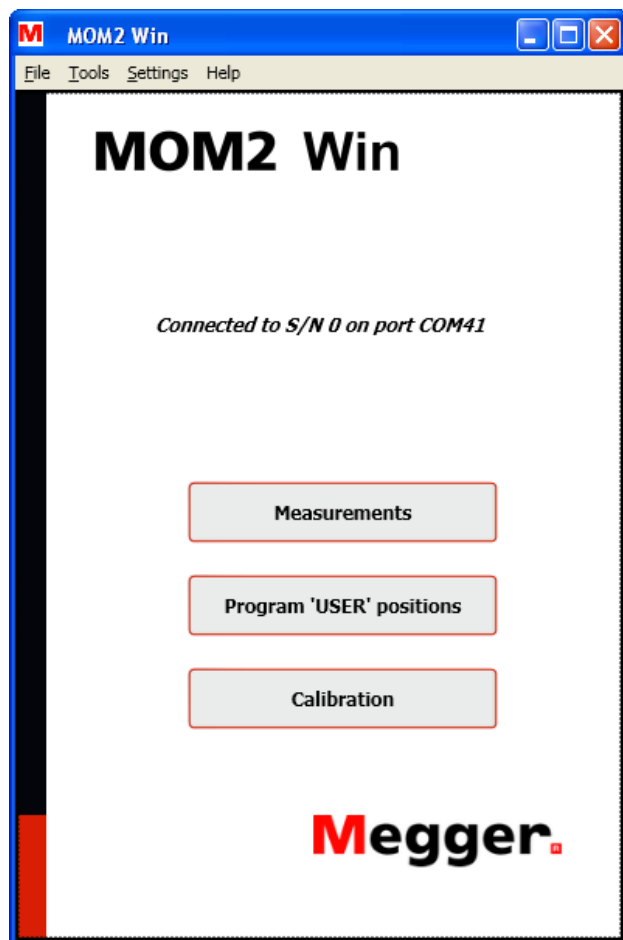

Figure 7.1 Start page

## Exit MOM2 Win

- 1] Exit the program by selecting "Exit" from the "File" menu or by clicking on the "X" button in the upper right corner of the window. The program will ask for a confirmation before it closes.

## 7.4 Connecting to MOM2

To establish the Bluetooth connection the MOM2 must be paired to the PC, see section 4.3.

### Automatic connecting

- 1] Turn the function selector to the **PC COM** position on the MOM2 instrument.

At program startup the SW will try to connect to MOM2 using the same COM port that the last successful connection used. If there have been no previous MOM2 connections from this computer the SW will scan all available COM ports. If there are several paired MOM2 instruments nearby the SW will connect to the first one detected. The connection status is shown on the start page, see Figure 7.1.

### Manual connecting

- 1] Open the "Connection settings" window from the "Settings" menu or double-click on the connection status text field on the start page. The "Connection settings" window will then pop up, see figure below

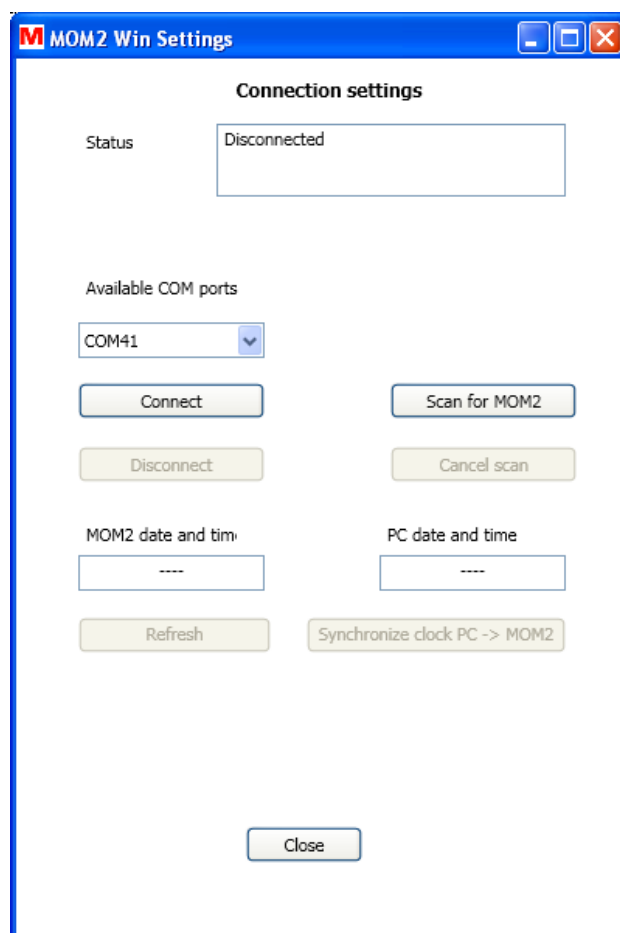

Figure 7.2 The Connection settings window, no connection established.

- 2] Choose a COM port in the drop down list and click the "Connect" button.

The program will try to connect to a MOM2 instrument over the specified COM port.

If it is unknown which COM port to use the program can scan all available ports until it finds a MOM2 instrument.

- 3] Click the button "Scan for MOM2".  
The operation can be interrupted with the "Cancel scan" button.

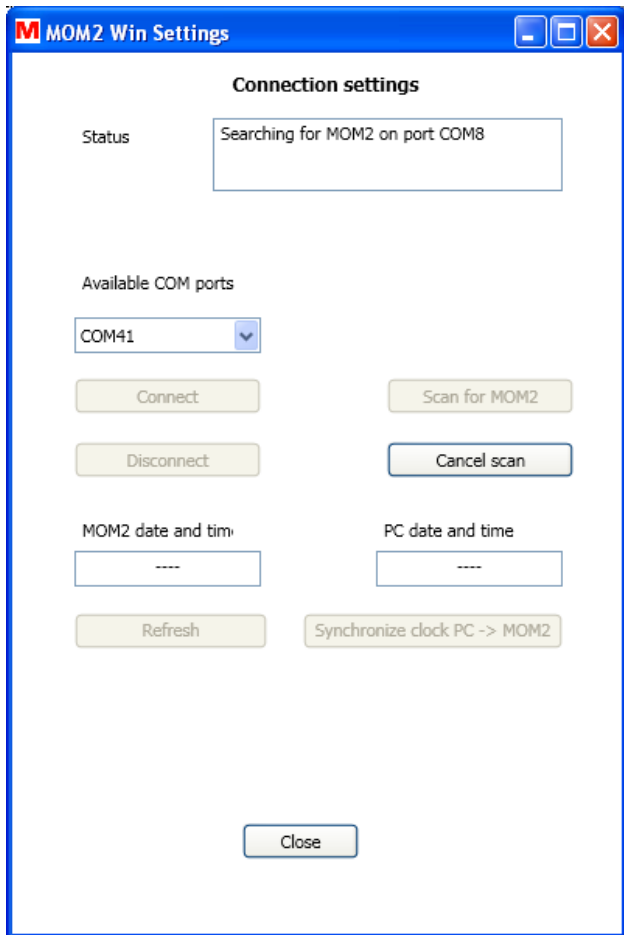

Figure 7.3 The Connection settings window, searching.



Figure 7.4 The Connection settings window, connection established.

### Refresh button

Provided that the MOM2 and the PC are connected to each other the "MOM2 date and time" and the "PC date and time" fields are updated every time you open the "Connection settings" window or when you click the "Refresh" button, see Figure 7.4

### Synchronize clock PC -> MOM2

When you click the "Synchronize clock PC -> MOM2" button the PC system time is written to the MOM2. This is the easiest way to set the clock in MOM2, see Figure 7.4

## 7.5 Read the measurement log

- 1] Click the "Measurements" button on the Start page or select "Measurements" from the "Tools" menu.

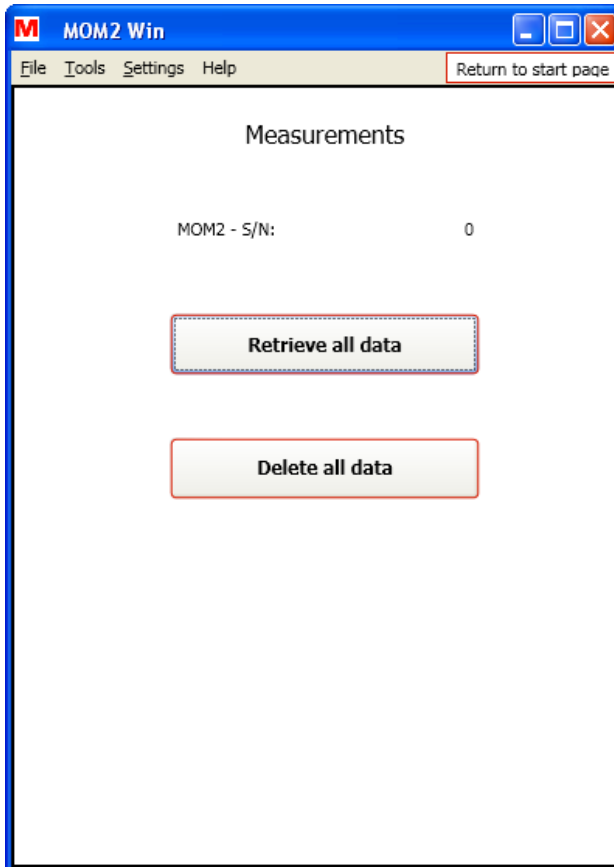

Figure 7.5 Data dumping dialog.

- 2] Click on the "Retrieve all data" button to download all measurements stored in the instrument.  
 A window will pop up showing the progress of the download.  
 At any time the data dump can be stopped by clicking the "Cancel" button. In that case the data window will be closed.

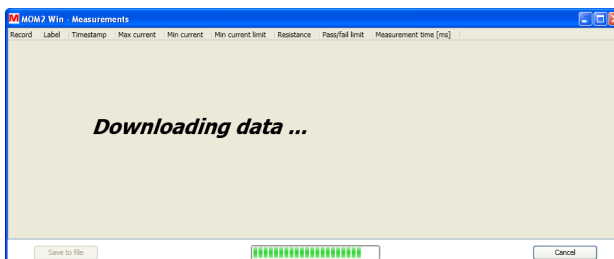

Figure 7.6 Data dumping progress.

Record	Label	Timestamp	Max current	Min current	Min current limit	Resistance	Pass/fail limit	Measurement time [ms]
1		19 2011-04-08 08:21:36	140 A	133 A	100 A	88 $\mu\Omega$	90 $\mu\Omega$	100
2		20 2011-04-08 08:23:49	243 A	229 A	0 A	88 $\mu\Omega$	90 $\mu\Omega$	100
17		17 2011-04-08 07:49:03	142 A	57 A	50 A	89 $\mu\Omega$		3000
18		18 2011-04-08 07:49:16	79 A	63 A	50 A	85 $\mu\Omega$		600
26		26 2011-04-08 07:54:52	57 A	54 A	50 A	85 $\mu\Omega$	80 $\mu\Omega$	100
27		27 2011-04-08 07:55:03	47 A	45 A	50 A	86 $\mu\Omega$	80 $\mu\Omega$	100
28		28 2011-04-08 07:59:20	43 A	41 A	50 A	88 $\mu\Omega$	90 $\mu\Omega$	100
29	1A1-1	2011-04-08 08:00:34	69 A	65 A	50 A	85 $\mu\Omega$	90 $\mu\Omega$	100
30	1A1-2	2011-04-08 08:00:43	69 A	65 A	50 A	86 $\mu\Omega$	90 $\mu\Omega$	100
31	1A1-3	2011-04-08 08:00:51	68 A	65 A	50 A	86 $\mu\Omega$	90 $\mu\Omega$	100
32	1A2-1	2011-04-08 08:01:10	67 A	64 A	50 A	87 $\mu\Omega$	90 $\mu\Omega$	100
33	1A2-2	2011-04-08 08:01:18	67 A	63 A	50 A	85 $\mu\Omega$	90 $\mu\Omega$	100
34	1A2-3	2011-04-08 08:01:26	67 A	63 A	50 A	86 $\mu\Omega$	90 $\mu\Omega$	100
35	1B1-1	2011-04-08 08:01:44	67 A	63 A	50 A	86 $\mu\Omega$	90 $\mu\Omega$	100
36	1B1-2	2011-04-08 08:01:53	67 A	63 A	50 A	87 $\mu\Omega$	90 $\mu\Omega$	100
37	1B1-3	2011-04-08 08:02:01	67 A	63 A	50 A	86 $\mu\Omega$	90 $\mu\Omega$	100
38	1B2-1	2011-04-08 08:02:12	67 A	64 A	50 A	86 $\mu\Omega$	90 $\mu\Omega$	100
39	1B2-2	2011-04-08 08:02:20	67 A	63 A	50 A	87 $\mu\Omega$	90 $\mu\Omega$	100
40	1B2-3	2011-04-08 08:02:28	67 A	63 A	50 A	87 $\mu\Omega$	90 $\mu\Omega$	100
41	1C1-1	2011-04-08 08:02:43	67 A	63 A	50 A	85 $\mu\Omega$	90 $\mu\Omega$	100
42	1C1-2	2011-04-08 08:02:51	67 A	63 A	50 A	85 $\mu\Omega$	90 $\mu\Omega$	100
43	1C1-3	2011-04-08 08:02:59	67 A	64 A	50 A	86 $\mu\Omega$	90 $\mu\Omega$	100
44	1C2-1	2011-04-08 08:03:15	67 A	63 A	50 A	86 $\mu\Omega$	90 $\mu\Omega$	100
45	1C2-2	2011-04-08 08:03:23	67 A	63 A	50 A	87 $\mu\Omega$	90 $\mu\Omega$	100
46	1C2-3	2011-04-08 08:03:32	67 A	63 A	50 A	88 $\mu\Omega$	90 $\mu\Omega$	100
47	2C1-1	2011-04-08 08:04:03	67 A	63 A	50 A	86 $\mu\Omega$	90 $\mu\Omega$	100
48	2B1-1	2011-04-08 08:04:16	67 A	63 A	50 A	85 $\mu\Omega$	90 $\mu\Omega$	100
49	2A1-1	2011-04-08 08:04:29	67 A	63 A	50 A	87 $\mu\Omega$	90 $\mu\Omega$	100

Figure 7.7 Data dumping finished. The columns can be sorted by clicking the headers and arranged by click-hold and drag.

## Export data to file

- 1] Click the "Save to file" button (this button is not enabled if the list is empty).  
A "Save as" window will be opened.
  - 2] Type a file name and click the "Save" button to export the data to file.
- A]** The default file type is (\*.csv) which will save the data as an ASCII file with comma separated values, suited for import to e.g. Microsoft Excel.

**Note** *The value separator is dependent of the regional setting in Windows, a semicolon when comma is used for decimal separator and comma otherwise.*

The format of the exported data is not the same as what is seen in the measurements table. There is no mixing of values and units, the units are placed in the column headers.

- B]** If file type (\*.txt) is selected the data will be saved with the values separated by tabs.

## Delete all data on the instrument

- 1] In the "Measurements" window, click the "Delete all data" button to erase all the measurements in the instrument log.

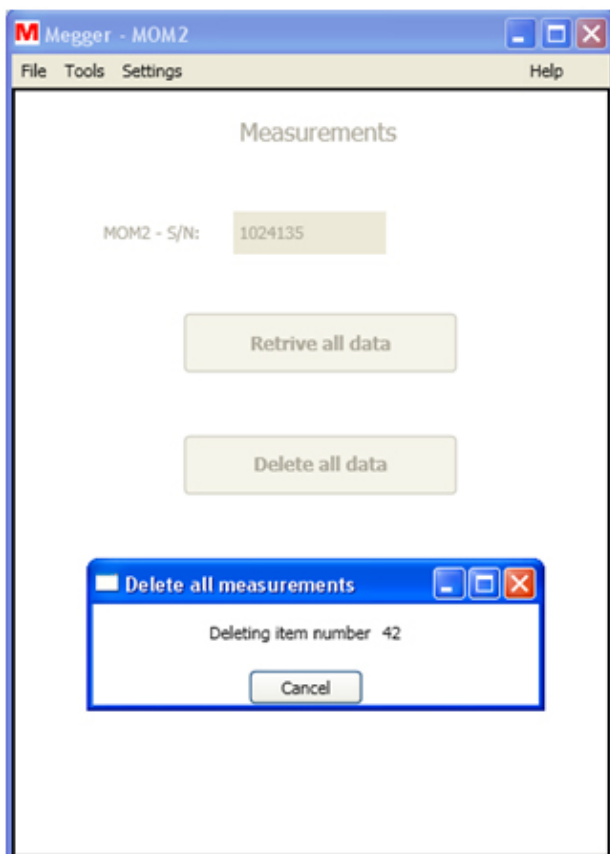

Figure 7.8 Delete all measurements progress.

## 7.6 User settings

- 1] Click the Program "User" positions button on the start page or choose Program "User" positions from the "Tools" menu .

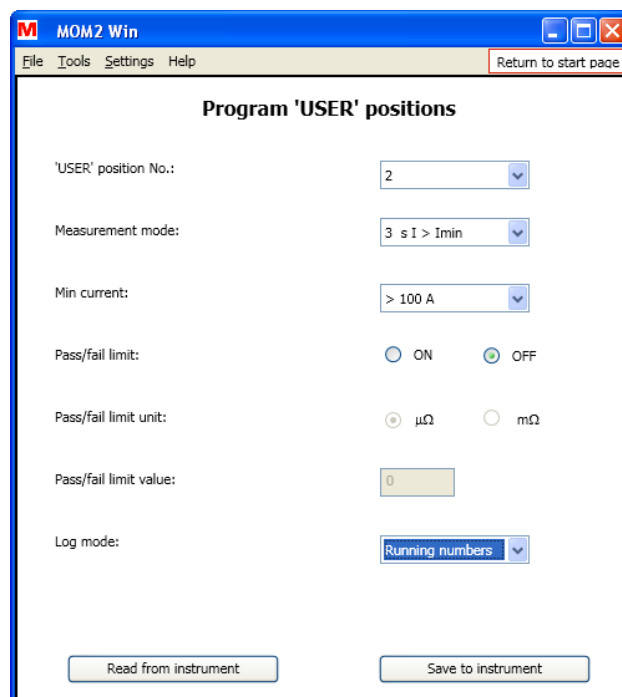

Figure 7.9 Program "User" positions

### Read existing settings

- 1] Select "User" position No." (1 – 3).
- 2] Click the "Read from instrument" button to see the current settings on the instrument. All three user settings will be read, not only the one selected in the combo box. The values for minimum current, pass/fail limit and type of logging will be updated.

### Program "User" positions

- 1] Make the desired settings and click the "Save to instrument" button.

**Note** *All three User positions will be updated on the instrument, not just the currently selected one.*

## 7.7 Calibration

Calibration is recommended to be made regularly at a yearly basis. Please contact your Megger sales representative or a Megger service center.

An alternative is to perform the calibration on your own. Then you will need the equipment listed below:

- Stable DC voltage source, 10 mV – 2000 mV
- Calibrated reference voltmeter
- Calibration kit (BD-90002)

### Procedure

- 1] Click the "Calibration" button on the Start page or select "Calibration" from the "Tools" menu to switch to the calibration page. The existing calibration factors will be read from the instrument and the calibration page will be disabled until it is finished.

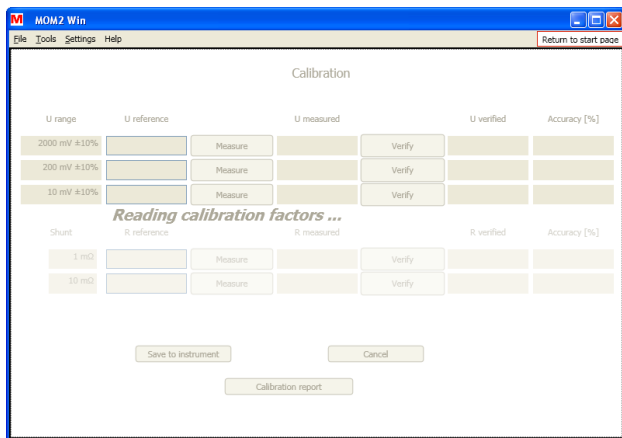

Figure 8.7.1 Calibration page. Loading calibration factors during startup.

### Voltmeter calibration

The voltmeter should be tested in three ranges.

- 1] Connect the voltage source to the MOM2 sense input, correctly polarized
- 2] Use the calibrated voltmeter and adjust to the stated reference voltages:
  - 10 mV  $\pm$ 10%
  - 200 mV  $\pm$ 10%
  - 2000 mV  $\pm$ 10%
- 3] Type the value in the U reference column in MOM2 Win
- 4] Click the "Measure" button next to the field. The value measured by the MOM2 will then be propagated to the "U measured" text field. New calibration factors will automatically be calculated.
- 5] Click the "Verify" button.

The voltage measured with the new calibration factor will be shown in the "U Verified" field. The deviation (in percent) from the reference value will be shown to the right.

- 6] Repeat from step 1 for the next two ranges.

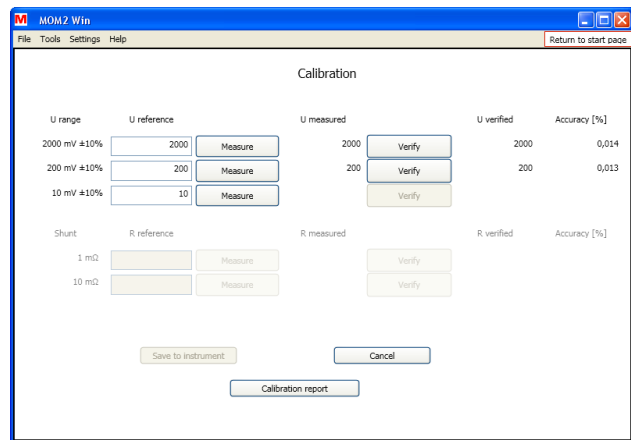

Figure 8.7.2 Voltmeter calibration

### Ammeter calibration

**Note** *The voltmeter in the instrument must be calibrated before it is possible to calibrate the Ammeter.*

The ammeter is calibrated in an indirectly manner by measuring the resistance over two predefined shunts and compare with the reference values. The resistance is measured with a capacitor voltage suitable for the voltage and current ranges.

- 1] Connect the current cables from the MOM2 to the reference shunt
- 2] Connect separate sense leads from the MOM2 sense input to the sense outputs of the reference shunt
- 3] Enter the value of the shunt in the "R reference" input field. The "Measure" button will be enabled if the resistance is within the limits.
- 4] Click the "Measure" button next to the field. When the measurement is started a progress window is shown, see fig. below. The two uppermost fields show the measured capacitor voltage and the target voltage.



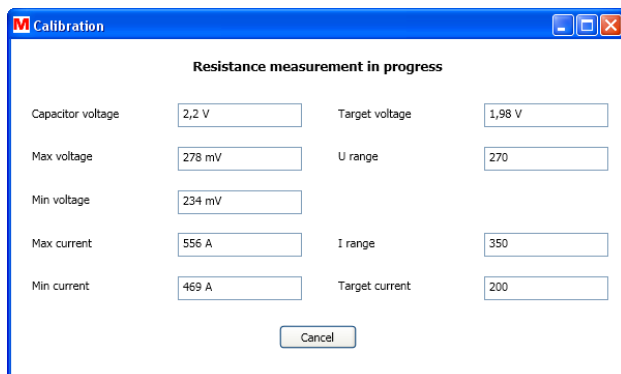

Figure 8.7.3 Resistance measurement progress window

- 5] The measurement goes on and when it is finished the "R Measured" field is filled with the measured resistance value and a new calibration factor for this measurement range is calculated, see fig. below.

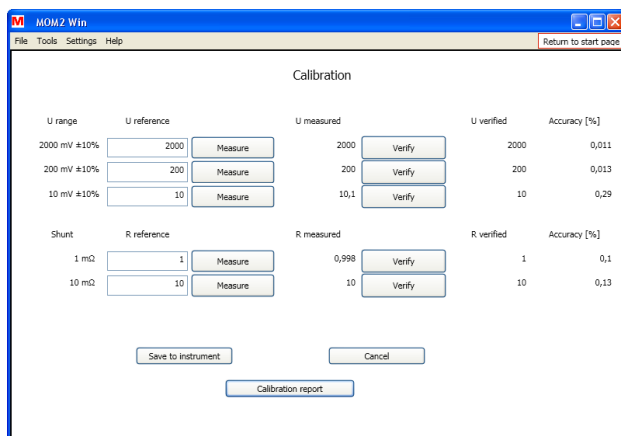

Figure 8.7.4 Ammeter calibration.

- 6] Click the "Verify" button.  
A measurement is started and the "Resistance measurement in progress" window will be shown.
- 7] Repeat from step 1 for the next reference shunt.  
When the resistances over both the shunts have been measured and the result is satisfactory you can save it to the MOM2.
- 8] Click the "Save to instrument" button.
- 9] If the result of the tests is not satisfying or you want to start over, click the "Cancel" button.  
This will empty the calibration dialog and the calibration factors are read from the instrument again.

## Calibration report

- 1] Click the "Calibration Report" button to show a preview of a calibration report. It can be opened at any time during the calibration. However, a complete report with

a calibration time can only be made when the calibration is completed and saved to the MOM2.

- 2] Click the "Print report" button to print the calibration report.

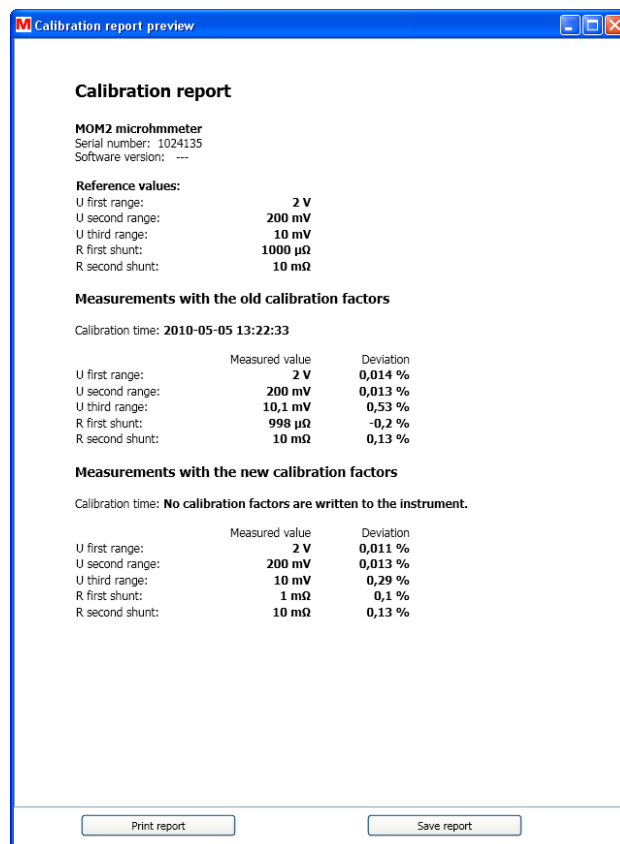

Figure 8.7.5 Calibration report.

# 8 Specifications

## SPECIFICATIONS

Specifications are valid at fully charged batteries and an ambient temperature of +25°C, (77°F). Specifications are subject to change without notice.

### Environment

**Application field** For use in high-voltage substations and industrial environments.

### Temperature

**Operation** -20°C to +50°C (-4°F to +122°F) \*)

**Storage** -40°C to +70°C (-40°F to +158°F)

**Relative humidity %RH** 5%-95%, non condensing

\*) Battery operation temperature 0°C to +50° (32°F to +122°F)

Battery charging temperature +10°C to +40° (50°F to +104°F)

### CE-marking

**EMC** 2014/30/EU

**LVD** 2014/35/EU

**RoHS** 2011/65/EU

### Classifications and standards

**Pollution degree** 2

**Shock** IEC 60068-2-27

**Vibration** IEC 60068-2-6

**Transport** ISTA 2A

**Flammability class** V0

### General

**Battery power** Five AA (HR6) 2500 mAh NiMH cells

**Recharge time** < 12 h

**Typical recharge time at 25°C** 3 h

### Battery charger

**Mains voltage** 100-250 V AC, 50 / 60 Hz

**Power consumption** 24 W

**Protection** Against wrong battery type, low/high temperature.

**Real time clock battery life** ≥10 years

**Audible feedback** Different buzzer sounds

**User presets** 3

**Field calibration** Yes

**Encapsulation** IP54

### Dimensions

**Instrument (excl. binding posts)** 217 x 104 x 72 mm

8.5 x 4.1 x 2.8 in.

**Carrying case** 395 x 300 x 190 mm

15.6 x 11.8 x 7.5 in.

**Weight** 1.0 kg (2.2 lbs) instrument only  
5.3 kg (11 lbs) with accessories and carrying case

### Measurement section

**Minimum current guarantee** Selectable 50 A / 100 A

Valid at resistance ≤2mΩ

**Pass / Fail** Settable from 1 μΩ to 1999 mΩ

**Number of measurements on fully charged batteries** typ. 2200 at I min = 50 A and 0.1 s

typ. 800 at I min = 100 A and 0.1 s

**Interference suppression** Yes

**Range** 0 - 1000 mΩ

**Range selection** Auto

**Resolution**

0 - 999 μΩ 1 μΩ

1.0 - 9.99 mΩ 0.01 mΩ

10.0 - 99.9 mΩ 0.1 mΩ

100 - 1000 mΩ 1 mΩ

### Inaccuracy

0 - 1999 μΩ ±1 % of reading ±1 digit

2 - 500 mΩ ±2 % of reading ±1 digit

500 - 1000 mΩ ±4 % of reading ±1 digit

### Outputs + / -

**Range** > 100 A DC (R < 2 mΩ)

**Output voltage (max)** 2.5 V DC

**Generation duration** Selectable: 0.1 s, 0.6 s, 3 s

Generation time	Recovery time at I min set to 100 A and load 100 μΩ	
	Max	Typ
0.1 s	10 s	8 s
0.6 s	20 s	16 s
3 s	130 s	100 s

### Inputs

#### SENSE + / -

**Connector** 4 mm banana jack

**Voltage** ±3 V DC

**Trigger input** Threshold 8 V DC

**DC IN** 12 - 24 V DC, 2 A max

### Logger

**Logger, Data** Label, Timestamp, I max, I min, I Limit, Resistance, Meas.time, P/F limit

**Labeling schemes** Circuit breaker oriented or running numbers

**Capacity** 180 measurements in running numbers mode

### Wireless communication

**PC communication** Bluetooth



# Index

<b>A</b>		<b>K</b>	
Application examples.....	32	Kelvin Clamp/Probe practice .....	23
Audio signals .....	19	Kelvin test.....	9
<b>B</b>		Keys.....	11
Basic technical description .....	9	<b>L</b>	
Battery charging .....	20	LCD display .....	22
Battery charging indicator.....	11	LOG.....	17
Battery charging LED indicator .....	20	low temperatures .....	23
Battery lid.....	11	<b>M</b>	
Battery power supply .....	20	Measurement on using Kelvin probes .....	32
Bluetooth .....	15	measurement time.....	22
Both sides grounded.....	9	Measurement using P/F .....	26
<b>C</b>		Measurement using P/F and I min.....	29
Calibration .....	40	Measurement using the LOG function.....	27
Clear log .....	11	Measurement with max. charge, I=I MAX .....	24
CLK.....	16	Measurement with minimum current guarantee, I>I MIN .....	25
Clock.....	16	Measurement with user defined settings .....	27
Connector for the battery charger.....	11	MOM2 installation.....	34
Connectors for trigger.....	11	MOM2 Win.....	34
Current output terminal (-) .....	10	<b>O</b>	
Current output terminal (+) .....	10	OFF .....	14
<b>D</b>		Operating instructions.....	22
Delete all reults.....	23	Optional accessories .....	13
Delete present test result.....	23	overview .....	10
Delete results.....	23	<b>P</b>	
display .....	22	Pass/Fail.....	18
Display.....	11	PC COM .....	19
DualGround .....	9	PC communication .....	19
<b>F</b>		P/F .....	18
Functions .....	14	Protective conductor terminal .....	10
Functions and set up .....	14	<b>R</b>	
Function selector .....	11	Recalling test results .....	23
<b>H</b>		Replacing batteries.....	20
Hold present test result.....	23	<b>S</b>	
<b>I</b>		Safety .....	6
I min.....	17	Safety instructions .....	6
Included accessories.....	12	Save test results .....	23
Input for sensing voltage (-).....	11	Service and support.....	8
Input for sensing voltage (+).....	11	set up.....	14
		Specifications .....	42

Stand-by / Wake up ..... 11

## **T**

Test a CB by injecting through the ground cables ..... 33

Test a CB using DualGround ..... 33

TEST button ..... 11

Testing on circuit breakers having a current transformer in the loop ..... 30

Test positions ..... 14

To choose  $I > I_{min}$  or  $I = I_{max}$  ..... 22

To choose measurement time ..... 22

Training courses ..... 8

Trouble shooting ..... 30

## **U**

USER– 1/2/3 ..... 14

User settings ..... 39

## **W**

Wake up ..... 11







## Local Sales office

Visit: [www.megger.com](http://www.megger.com)

## Manufacturing sites

Megger Limited  
Archcliffe Road  
Dover  
Kent  
CT17 9EN  
ENGLAND

T. +44 (0)1 304 502101

F. +44 (0)1 304 207342

Megger GmbH  
Weststraße 59  
52074 Aachen  
T. +49 (0) 241 91380 500  
E. [info@megger.de](mailto:info@megger.de)

Megger USA - Valley Forge  
Valley Forge Corporate Center  
2621 Van Buren Avenue  
Norristown  
Pennsylvania, 19403  
USA

T. +1 610 676 8500

F. +1 610 676 8610

Megger USA - Dallas  
4545 West Davis Street  
Dallas TX 75237  
USA

T. 800 723 2861 (USA only)

T. +1 214 333 3201

F. +1 214 331 7399

E. [USSales@megger.com](mailto:USSales@megger.com)

Megger AB  
Rinkebyvägen 19, Box 724,  
SE-182 17 DANDERYD  
SWEDEN

T. +46 08 510 195 00

E. [seinfo@megger.com](mailto:seinfo@megger.com)

Megger USA - Fort Collins  
4812 McMurry Avenue  
Suite 100  
Fort Collins CO 80525  
USA

T. +1 970 282 1200

**This instrument is manufactured in SWEDEN.**

**The company reserves the right to change the specification or design without prior notice.**

**Megger is a registered trademark**

© Megger Limited 2023

[www.megger.com](http://www.megger.com)